

Bidder: McCullough Equipment, Inc. dba McCullough Kubota Bidder's E-Mail Address:
dwawrzyniec@mcagplus.com



COOK COUNTY GOVERNMENT
Office of the Chief Procurement Officer

**CONTRACT FOR SUPPLIES
NON-FEDERALLY FUNDED CONTRACT**

Contract No. 2457-10011R, Purchase Order No. 70000386074

**Tractor Mowers with Attachments
FOR
DEPARTMENT OF TRANSPORTATION AND HIGHWAYS**

QUESTIONS:

Any questions regarding this Bid should be submitted via Bonfire.

Questions submission deadline: October 9, 2025 at 1:00 p.m. Local Time - Chicago

BIDS DUE DATE: November 5, 2025 at 10:00 a.m. Local Time - Chicago

BIDS MUST BE UPLOADED TO:

LATE BIDS WILL NOT BE CONSIDERED

BUYER CONTACT INFORMATION:

Buyer: ANGELIQUE RANDLE

E-Mail: ANGELIQUE.RANDLE@COOKCOUNTYIL.GOV

**Toni Preckwinkle
Cook County Board President**

**Raffi Sarrafian
Chief Procurement Officer**

TABLE OF CONTENTS

<u>Section</u>	<u>Page</u>
Instructions to Bidders	IB-1
General Conditions	GC-1
Special Conditions	SC-1
Specifications	S-1
Site Inspection Certificate	SI-1

EXHIBITS:

Exhibit I	Instructions for Submitting an Electronic Bid
Exhibit II	Identification of Subcontractor/Supplier/Subconsultant Form
Exhibit III	Electronic Payables Program Form
Exhibit IV	Preference for Veteran’s Business Enterprise and Service-Disabled Veteran’s Business Enterprise Form
Exhibit V	Social Enterprise Preference Form
Exhibit VI	Veteran’s Workplace Preference Public Works Contracts Form
Exhibit VII	Preference for Businesses Owned by People with Disabilities Form
Exhibit VIII	Board Approval (If Applicable)
Exhibit IX	Minority-Owned Business Enterprise and Women-Owned Business Enterprise Utilization Plan
Exhibit X	Certificate of Insurance
Exhibit XI	Addenda Acknowledgement Form (If Applicable)
Exhibit XII	Bid Page
Exhibit XIII	Economic Disclosure Statement Forms, <i>including Contract and EDS Signature Pages</i>

**INSTRUCTIONS TO BIDDERS
 BID CONTRACTS
 INDEX**

<u>Section</u>	<u>Subject</u>	<u>Page</u>
IB-01	Definitions	IB-1
IB-02	Preparation of EDS and Execution Document	IB-2
IB-03	Site Inspection Certificate	IB-2
IB-04	Bid Deposit	IB-2/3
IB-05	Exceptions and Addendum	IB-3
IB-06	Bidder Representations and Warranties	IB-3
IB-07	Submission of Bid Proposals	IB-3
IB-08	Bid Proposals to Conform to Contract Documents	IB-3
IB-09	Competency of Bidder	IB-4
IB-10	Local Business Preference	IB-4
IB-11	Re-Entry Employment Earned Credits	IB-4
IB-12	Eligible Veterans Bid Preference for Public Works Contract	IB-4
IB-13	Eligible Bid Preference for VBEs and SDVBES	IB-4
IB-14	Eligible Bid Preference for Businesses Owned by People with Disabilities	IB-4
IB-15	Public Works	IB-5
IB-16	Consideration of Bid Proposals	IB-5
IB-17	Withdrawal of Bid Proposals	IB-5
IB-18	Notice of Award	IB-5
IB-19	Bid Disputes	IB-6
IB-20	Performance and Payment Bond	IB-6
IB-21	Prices Firm	IB-6
IB-22	Cash Billing Discounts	IB-6
IB-23	Catalogs	IB-6
IB-24	Authorized Dealer/Distributor	IB-6
IB-25	Trade Names	IB-7
IB-26	Samples	IB-7

**INSTRUCTIONS TO BIDDERS
BID CONTRACTS
INDEX (continued)**

IB-27	Notices	IB-7
IB-28	Compliance with Laws - Public Contracts	IB-7
IB-29	Cooperation with Inspector General	IB-7
IB-30	Credit Card Payments	IB-8
IB-31	Minority and Women Owned Business Enterprise Ordinance	IB-8
IB-32	Cook County Recycled Product Procurement Policy	IB-8
IB-33	Estimated Quantities	IB-8
IB-34	Coalition of Unionized Public Employees	IB-8

INSTRUCTIONS TO BIDDERS

IB-01 DEFINITIONS

- A. **BIDDER** shall mean any Person who submits a Bid.
- B. **BID COVER PAGE** shall mean the general description of the required services, goods, equipment, or supplies, the contact information of the assigned Contract Negotiator or Specification Engineer in the Office of the Chief Procurement Officer, and shall include the date and time for the submission of Bid Proposals.
- C. **BID or BID PROPOSAL** shall mean a response to the Bid Notice containing all Bid Documents and any other documents or information the Bidder is required to provide.
- D. **BID DOCUMENTS** means the documents, specifications, forms and other information necessary and required for a Bid.
- E. **BID NOTICE** means the notice from the CPO regarding a Procurement which shall include: a general description of the Procurement; information necessary to obtain the Bid Documents; and the date, time and process for the submission of Bids.
- F. **CONTRACT** shall mean any written document to make Procurements by or on behalf of Cook County.
- G. **CONTRACT DOCUMENTS** shall mean collectively the Bid Cover Page, legal advertisement, Bid Notice, Bid Documents, Bid, Economic Disclosure Statement, MBE/WBE Utilization Plan and any other document required by the Chief Procurement Officer. The above documents shall be considered as one integrated document setting forth the obligations of the parties.
- H. **CONTRACTOR** shall mean the Person that enters into a Contract with the County.
- I. **COUNTY** shall mean the County of Cook, a body politic and corporate of the State of Illinois.
- J. **DIRECTOR** shall mean the person or persons authorized by the County to act in connection with this Contract. Such authorization shall not include any power to change the scope of the Contract or to obligate the County to pay additional sums beyond the amount of the Contract awarded by the Cook County Board of Commissioners or the Chief Procurement Officer.
- K. **CHIEF PROCUREMENT OFFICER or CPO** shall mean the Chief Procurement Officer of the County of Cook whose duties and responsibilities are more particularly described in the Cook County Procurement Code, Chapter 34, Article IV, Division I.
- L. **OCPO** shall mean the Office of the Chief Procurement Officer of Cook County.
- M. **PERSON** shall mean any individual, corporation, partnership, Joint Venture, trust association, Limited Liability Company, sole proprietorship or legal entity.
- N. **PROCUREMENT** shall mean obtaining supplies, equipment, goods or services of any kind.
- O. **SPECIFICATIONS** shall mean the description of the services, work, goods, equipment, personnel, volume and use statistics and all requirements for the scope of work set forth in the Contract Documents.
- P. **USING AGENCY** shall mean the departments or agencies within Cook County government including elected officials.

IB-02 PREPARATION OF EDS AND EXECUTION DOCUMENT

- A. The Bidder shall prepare one (1) copy of its Bid Proposal on the proposal forms within the Contract Documents and one (1) Economic Disclosure Statement and Execution Documents (“EDS”), all with original signatures. Unless otherwise stated, all blank spaces on the proposal forms shall be fully completed. Bidder bears all responsibility for error or omissions in the submission of the Bid Proposal. Bid Proposals and EDS which are not properly signed may be rejected.
- B. If the Bidder is a corporation, the President and Secretary must execute the EDS. In the event that this Bid Proposal is executed by someone other than the President, attach hereto a certified copy of that section of the Corporate By-Laws, resolution or other authorization by the Corporation, satisfactory to the County that permits the person to execute Bid Proposal for said corporation. If the corporation is not incorporated in the State of

INSTRUCTIONS TO BIDDERS

Illinois, a copy of the Certificate of Good Standing from the state of incorporation must be submitted with the EDS.

- C. If the Bidder is a partnership or joint venture, all partners or joint venturers must execute the EDS, unless one partner or joint venture has been authorized to sign for the partnership or joint venture, in which case, the partnership agreement, resolution or evidence of such authority, satisfactory to the County, must be submitted. If the Bidder is a joint venture, attach a copy of the joint venture agreement.
- D. If the Bidder is a member-managed LLC all members must execute the EDS, unless otherwise provided in the operating agreement, resolution or other corporate documents. If the Bidder is a manager-managed LLC, the manager(s) must execute the Bid Proposal. The Bidder must attach either a certified copy of the operating agreement, resolution or other authorization, satisfactory to the County, demonstrating such person has the authority to execute the EDS on behalf of the LLC. If the LLC is not registered in the State of Illinois, a copy of a current Certificate of Good Standing from the state of incorporation must be submitted with the EDS.
- E. If the Bidder is a Sole Proprietorship, the sole proprietor must execute the EDS.
- F. A "Partnership" "Joint Venture" or "Sole Proprietorship" operating under an Assumed Name must be registered with the Illinois county in which it is located, as provided in 805 ILCS 405 (2012) and documentation evidencing registration must be submitted with the EDS.

IB-03 SITE INSPECTION CERTIFICATE

The Bidder shall inspect the job-site to become familiar with the conditions related to the work or services and the requirements set forth in the Bid Documents. Failure of the Bidder to visit the Site shall not relieve or alter the Bidder's responsibility for completing the work or services as required by the Contract Documents.

When required as mandatory in the Contract Documents, the Bidder shall visit the job-site and shall carefully examine and become familiar with all conditions which may in any way affect the performance of the Contract and shall submit certification of such inspection along with the Bid Proposal. The dates and conditions of the site inspection are determined by the County. If the Contract Documents provide that inspection of the site is mandatory, a Bidder's failure to attend all of the required site inspections shall render the Bid Proposal non-responsive.

IB-04 BID DEPOSIT

When required in the Contract Documents, the Bid Proposal shall be accompanied by, cashier's check, certified check, bank draft or surety bond in the amount shown in the legal advertisement or as may be prescribed in these Contract Documents. A certified or cashier's check shall be drawn on a responsible bank doing business in the United States and shall be made payable to the order of the County of Cook. The surety issuing the bond must have a general rating of "A", and shall be a Class VII or higher in the financial size category as defined by Best Company Inc., Moody's Investor Services, Standard & Poor's Corporation or similar rating agency. The surety must be licensed by the State of Illinois Department of Insurance and be listed in the current U.S. Treasury Circular 570 when federal funds are being used. Failure to submit the bid deposit shall constitute a non-responsive Bid Proposal and such Bid Proposal shall be rejected.

IB-04 BID DEPOSIT (con't.)

The Bidder hereby agrees that the bid deposit shall be forfeited to the County as liquidated damages and not as penalty in the event Bidder fails to comply with IB-15 and IB-17, or otherwise fails or refuses to honor the Bid Proposal upon award of the Contract by the County.

The bid deposit of all bidders will be returned, with the exception of the apparent lowest responsive and responsible Bidder, after the County has awarded the Contract. The bid deposit of the lowest responsive and responsible Bidder will be returned after the Contract has been awarded and the Bidder has submitted all insurance documentation and the Performance and Payment Bond, as required by the Contract Documents.

IB-05 EXCEPTIONS AND ADDENDUM

The County will not provide oral answers to questions concerning Bid Documents before or subsequent to the award of a Contract. If an interpretation or clarification of the Bid Document is desired by the Bidder or if the Bidder intends to request a deviation to the Specifications, the Bidder shall submit questions or request for the deviation to the Specifications to the Chief Procurement Officer prior to the date for inquiries set forth in the Special Conditions. The Chief Procurement Officer will answer questions or requests for deviations to the Specifications by issuing an Addendum which shall be available to all Bidders submitting a Bid Proposal. If no Addendum is issued by the Chief Procurement Officer, then such deviation or

INSTRUCTIONS TO BIDDERS

exception to the Specification shall be deemed rejected. The Chief Procurement Officer shall reject any Bid containing deviations or exceptions to the Specifications not previously accepted through a written Addendum. Bidder shall acknowledge receipt of each Addendum issued in the provided Addenda Acknowledgement Form. The Bidder's failure to acknowledge in writing any issued addenda may result in the CPO finding the Bid non-responsive and rejecting the Bid. The OCPO shall not allow any Bidder to acknowledge any such addenda, in writing or orally, after the bidding period has closed.

All written requests for clarifications, deviations or exceptions shall be submitted via Bonfire and addressed to the Buyer listed on the Bid Cover Page.

If the apparent lowest Bidder takes exceptions or deviations to the General Conditions, which are submitted with the Bid, the CPO shall reject the Bid as non-responsive in the event that the Chief Procurement Officer, in his or her sole opinion, determines such exceptions or deviations to be material.

IB-06 BIDDER REPRESENTATIONS AND WARRANTIES

The submission of a Bid shall constitute a representation and warranty that: (i) Bidder has carefully and thoroughly reviewed the Contract Documents and has found them complete and free from ambiguities and sufficient to describe the required goods, equipment, supplies or services; (ii) Bidder and all laborers, employees or subcontractors it intends to use in the performance of this Contract are skilled and experienced in the type of work or services called for by the Contract Documents; and (iii) neither the Bidder nor any of its employees, agents, suppliers or subcontractors have relied on any verbal representations from the County, or any of the County's employees, agents, or consultants, in preparing the Bid.

IB-07 SUBMISSION OF BID PROPOSALS

All Bidders shall submit Bids to the OCPO electronically as per the instructions in Exhibit I Instructions for Submitting an Electronic Bid. OCPO will not accept hardcopy Bids. Bidders are instructed not to send Bids via US Mail or any other carrier service.

IB-08 BID PROPOSALS TO CONFORM TO BID DOCUMENTS

The County will not entertain or consider any Bids: (i) received after the exact time specified in the Bid; (ii) not accompanied by the required bid deposit; or (iii) in any other way failing to comply fully with the conditions stated in the Bid.

IB-09 COMPETENCY OF BIDDER

No Contract shall be awarded to a Bidder that is in arrears or is in default to the County upon any debt or Contract, or that is a defaulter, as surety or otherwise upon any obligation to said County, or has failed to perform faithfully any previous contract with the County.

IB-10 LOCAL BUSINESS PREFERENCE

The Chief Procurement Officer shall, for all Procurements funded solely with County dollars by competitive sealed bidding, accept the lowest bid price or lowest evaluated bid price from a responsive or responsible local business, provided that the Bid does not exceed the lowest bid price or lowest evaluated bid price from a responsive and responsible non-local business by more than five percent (5%).

"Local business" shall mean a Person, including a foreign corporation authorized to transact business in Illinois, having a bona fide establishment located within the County at which it is transacting business on the date when a Bid is submitted to the County, and which employs the majority of its regular, full-time work force within the County. A Joint Venture shall constitute a Local Business if one or more Persons that qualify as a "Local Business" hold interests totaling over 50 percent in the Joint Venture, even if the Joint Venture does not, at the time of the Bid submittal, have such a bona fide establishment within the County.

IB-11 RE-ENTRY EMPLOYMENT EARNED CREDITS

In accordance with Section 34-231 through Section 34-235 of the Cook County Procurement Code, for all Public Works Contracts, with an estimated Bid Price of \$100,000 or more, the Bidder shall be permitted but is not required, to submit an employment plan of Former Offenders with its Bid Proposal in order to receive an earned credit for future Public Works Contracts. The Employment Plan shall be approved by the CPO and, if required, the Cook County Re-entry Employment Committee. Upon the completion of a qualifying contract and the Bidder presenting satisfactory information and documentation to the CPO, the CPO shall provide the Bidder with an Earned Credit Certificate, which shall be valid for three years from the date of issuance. The Bidder shall receive an earned credit of ½% of the Bid Price for future Public Works Contracts, if 5-10% of the percentage of Total Labor Hours are performed by Former Offenders, and an earned credit of 1% of the Bid Price for future Public Works Contracts, if the more than 10% of the percentage of Total Labor

INSTRUCTIONS TO BIDDERS

Hours are performed by Former Offenders. For purposes of this provision, "Former Offenders" shall mean adults who are residents of the County and who have been convicted of a crime. "Labor hours" shall mean the total hours of workers receiving an hourly Wage who are directly employed at the work site. It shall include hours performed by workers employed by the contractor and all subcontractors working at the site. "Labor hours" shall not include hours worked by nonworking former, superintendents, owners and workers who are not subject to prevailing wage requirements.

IB-12 ELIGIBLE VETERANS BID PREFERENCE FOR PUBLIC WORKS CONTRACT

In accordance with Section 34-236 (a) of the Cook County Procurement Code, for all Public Works Contracts, the CPO shall give a preference of one percent of the amount of the Contract to a Responsible and Responsive Bidder for a Public Works Contract when such Bidder has committed by affidavit to utilize Eligible Veterans for at least five percent of the hours worked under such Contract. Failure to utilize Eligible Veterans in accordance with the affidavit will result in breach of Contract.

IB-13 ELIGIBLE BID PREFERENCE FOR VBEs and SDVBEs

In accordance with Section 34-236 (b) of the Cook County Procurement Code, the CPO shall give a preference of five percent of the amount of the Contract to a Responsible and Responsive Veteran owned Business Enterprises ("VBEs") or Service Disabled Veteran owned Business Enterprises ("SDVBE") certified by the Contract Compliance Director ("CCD"), or by any other entity approved by the CCD.

IB-14 ELIGIBLE BID PREFERENCE FOR BUSINESSES OWNED BY PEOPLE WITH DISABILITIES

In accordance with Section 34-242 (a) of the Cook County Procurement Code, the CPO shall recommend award to the lowest Responsible and Responsive Bidder who is a PDDBE, provided that the Bid of such bidder does not exceed the Bid of the lowest Responsible and Responsive Bidder by more than five percent (5%).

IB-15 PUBLIC WORKS

For all Public Works Projects, the Bidder shall comply with Section 34-190 of the Cook County Procurement Code, which requires that Public Works Contracts having an estimated contract price of \$100,000 or more, where not otherwise prohibited by Federal or State law, shall have at least 50 percent of the total hours worked on the site by employees of the Contractor and subcontractors shall be performed by residents of the County.

All Bid Proposals for Public Works Construction shall be evaluated to determine, whether the Bidder is responsible, in accordance with Section 34-145 of the Cook County Procurement Code. In accordance with Section 34-145 the CPO shall determine whether the Bidder: (i) is authorized to do business in Illinois and the County; (ii) has, as applicable, a Federal Employer Identification Number or Social Security; (iii) meets any applicable insurance requirements in the Bid Document; (iv) has certified that it is in compliance with all provisions of the Illinois Prevailing Wage Act, and State and Federal equal employment opportunity laws; (v) has certified that it participates in active apprenticeship and training programs approved and registered with the United States Department of Labor Bureau of Apprenticeship and Training for each of the trades of work contemplated under the awarded Contract; (vi) contractually requires any subcontractor to participate in active apprenticeship and training programs approved and registered with the United States Department of Labor Bureau of Apprenticeship and Training for each of the trades of work contemplated under the awarded Contract; and (vii) has agreed to provide Certified payrolls as specified in the Illinois Prevailing Wage Act.

IB-16 CONSIDERATION OF BID PROPOSALS

The County reserves the right to reject or accept any or all Bid Proposals, to extend the bidding period, to waive technicalities in the Bid and/or to withdraw or cancel the Bid or to issue a new Bid, i.e., "rebid" prior to award of the Contract.

No physical public bid opening shall be held. A preliminary record of all bids received will be posted to the OCPO website and shall be made available immediately after the bids are opened.

After the bidding period has closed, the Bid Proposals will be evaluated based on the price, conformance with Specifications, the responsibility of the various Bidders taking into consideration factors including, but not limited to, those noted in IB-09, IB-10 and responsiveness to the County's Minority and Women Owned Business Ordinance. The Chief Procurement Officer reserves the right to make corrections, after receiving the Bids, to any clerical error apparent on the face of the Bid, including but not limited to obviously incorrect units or misplaced decimal points, or arithmetic errors. In the event that comparison of the Bidder's "Unit Price" and "Total Price" submitted for any line items reveals a calculation error, the Unit Price will prevail.

The Chief Procurement Officer reserves the right to reject any Bid that, in his or her discretion and authority is deemed materially unbalanced.

INSTRUCTIONS TO BIDDERS**IB-17 WITHDRAWAL OF BID PROPOSALS**

Bidders may withdraw their Bid Proposals at any time prior to the time specified in the Bid as the date and hour set for the Bid Due Date. However, no Bidder shall withdraw, cancel or modify its Bid Proposal for a period of ninety (90) calendar days after the Bid Due Date.

IB-18 NOTICE OF AWARD

The Chief Procurement Officer shall notify the successful Bidder, in writing, of award of the Contract by the County within ninety (90) days from the Bid Opening date. Upon receipt of the Notice of Award, the Contractor shall promptly secure, execute and deliver to the Chief Procurement Officer any documents required herein.

IB-19 BID DISPUTES

Section 34-136 of the Cook County Procurement Code permits Bidders to file protests. Any Bidder who reasonably believes that the recommended Bidder is not the lowest Responsive and Responsible Bidder, or has a complaint about the bid process, may submit a bid protest, in writing, and directed to the CPO, within three business days after the date upon which the CPO posts the recommended Bid for award or execution on the County's website. The bid protest must specify why the protester believes the recommended Bidder is not the lowest Responsive and Responsible Bidder, or why the protester believes the bid procedure was unfair, including a statement of how the alleged unfairness prejudiced the protesting Bidder and the action requested of the CPO. A bid protest based on an issue which could have been clarified through a request for clarification or information pursuant to Section 34-136(d), and IB-05, Communications with the County regarding competitive bidding process, will not be considered if the protesting Bidder failed to make such request. When a bid protest has been submitted, no further action shall be taken on the Procurement until the CPO makes a decision concerning the bid protest, unless the Using Agency responds in writing and sufficiently demonstrates that (i) the item to be procured is urgently required and (ii) failure to make the award promptly will unduly delay delivery or performance or cause other undue harm.

The CPO shall issue a written decision on the bid protest to the protesting Bidder and to any other Bidder affected by such decision as soon as reasonably practicable. If the bid protest is upheld based on a lack of fairness in the bid procedure, the CPO shall re-bid the procurement. If the CPO determines that the recommended Bidder was not Responsive and Responsible, that Bidder shall be disqualified and the CPO may either recommend the lowest Responsive and Responsible Bidder or re-bid. Any CPO decision concerning bid protests shall be final.

IB-20 PERFORMANCE AND PAYMENT BOND

When required in Bid Documents, the successful Bidder shall furnish a Performance and Payment Bond in the full amount of the Contract on the County Form, a specimen of which shall be provided. The Surety issuing the Performance and Payment Bond must have a general rating of "A" and shall be a Class VII or higher in the financial size category as defined by Best's Key Rating Guide-Property and Casualty, or have such ratings as specified in the Contract Documents.

In the event that the Bidder fails to furnish the Performance and Payment Bond within fourteen (14) calendar days after service of the Notice of Award, the County may elect to retain Bidder's bid deposit as liquidated damages and not as a penalty and reject the Bid. The parties agree that the sum of the bid deposit is a fair estimate of the amount of damages that the County will sustain due to the Bidder's failure to furnish the Performance and Payment Bond and the termination of the Contract.

IB-21 PRICES FIRM

All prices quoted in the Bid Proposal shall be firm and will not be subject to increase during the term of the Contract, except as otherwise provided in these Contract Documents.

IB-22 CASH BILLING DISCOUNTS

Cash billing or percentage discounts for payment will not be considered in evaluating Bid Proposals.

IB-23 CATALOGS

Each Bidder shall submit, where necessary or when requested catalogs, descriptive literature, and detailed drawings, fully detailing features, designs, construction, appointment and finishes not covered in the Specifications but necessary to fully describe the goods, equipment, supplies or services.

INSTRUCTIONS TO BIDDERS**IB-24 AUTHORIZED DEALER/DISTRIBUTOR**

For goods, equipment and supplies, the Bidder must be one of the following: (i) the manufacturer; (ii) an authorized dealer/distributor; or (iii) able to promptly secure the necessary genuine parts, assemblies and/or accessories as supplied by the original equipment manufacturer (O.E.M.), along with any necessary schematics or drawings to fulfill the contractual obligations. With respect to the purchase of vehicles, or services related to vehicles, the Specifications or Special Conditions may require that the Bidder be an authorized dealership of the manufacturer. The Bidder must be able to furnish original product warranty and manufacturer's related services such as product information, product re-call notices, etc. Proof of ability to transfer product warranty to the County is to be submitted with the Bid Proposal.

IB-25 TRADE NAMES

In cases where an item is identified by a manufacturer's name, brand name, trade name, catalog number, or reference, it is understood that the Bidder proposes to furnish the item identified and does not propose to furnish an alternate but equivalent item, unless the Bidder has proposed and the County has accepted the alternate but equivalent item.

Unless the Bid states that no substitute shall be allowed, the reference to a manufacturer's name, brand name, trade name, catalog number, or reference is intended to be descriptive and not restrictive and to indicate to prospective Bidders articles that shall be satisfactory. Bid Proposals for other manufacturer names, brand names, trade names, catalog numbers or references shall be considered, provided each Bidder states on the face of the Bid Proposal what alternate, but equivalent items are being proposed.

If the Bidder proposes alternate, but equivalent, items, the Bidder must provide the following: (i) product identification, including manufacturer's name and address; (ii) manufacturer's literature identifying the product description, reference standards and performance and test data; (iii) samples, as applicable; and (iv) itemized comparisons of the proposed alternate items listing significant variations. If a Bidder proposes alternate items, it warrants and represents that in making a formal request for substitution that: (i) the proposed alternate item is equivalent to or superior in all respects to the item specified in the Bid; and (ii) that the same warranties and guarantees will be provided for the proposed alternate items as those specified in the Bid. The CPO may, in his or her sole discretion accept an alternate item for a specified item, provided the alternate items so bid is, in the CPO's sole opinion the equivalent of the item specified in the Bid. An alternate item that the CPO determines not to be equivalent to the specified item shall render the bid non-responsive and the CPO shall reject the Bid.

IB-26 SAMPLES

Bidders may be asked upon request of the Chief Procurement Officer, including subsequent to the Bid Due Date, to furnish and deliver a representative sample sufficient to effectively evaluate each item listed in the Bid Proposal. All samples must be delivered F.O.B. DESTINATION, FREIGHT PREPAID to an identified delivery location within five (5) business days of the request. Samples submitted must be identical to those specified in the Bid Proposal. Submission of other than the samples reflected in the Bid Proposal or failure to furnish samples within the required time period shall be cause for rejection of the Bid Proposal. All samples are subject to mutilation and will not be returned. Bidders shall bear the cost of any samples and shipping or delivery costs related thereto.

IB-27 NOTICES

All communications and notices between the County and Bidders regarding the Bid Documents shall be in writing, sent to the contact person listed on the cover of this bid solicitation via e-mail. Notices to the Bidders shall be addressed to the name and email address provided by the Bidders; notices to the Chief Procurement Officer shall be addressed to the Chief Procurement Officer and the contact person listed on the cover of this bid solicitation.

IB-28 COMPLIANCE WITH LAWS - PUBLIC CONTRACTS

This is a competitive Bid of Cook County government subject to laws and ordinances governing public bids and contracts. The Bidder shall at all times observe and comply with all laws, ordinances, regulations and codes of the Federal, State, County and other local government agencies which may in any manner effect the preparation of the Bid Proposal or the performance of the Contract. If the Bidder observes that any of the Bid Documents are at variance with any laws, ordinances, regulations or codes, it shall promptly notify the Chief Procurement Officer in writing and if necessary an addendum shall be issued by the Chief Procurement Officer.

IB-29 COOPERATION WITH INSPECTOR GENERAL

Persons or businesses seeking County contracts are required to abide by all of the applicable provisions of the Office of the Independent Inspector General Ordinance (Section 2-281 et. seq. of the Cook County Code of Ordinances). Failure to cooperate as required may result in monetary and/or other penalties.

INSTRUCTIONS TO BIDDERS**IB- 30 CREDIT CARD PAYMENTS**

The County has implemented a Prompt Payment Program (the "E-Payables Program"). Bidders who voluntarily participate in the Program will receive prompt payments via the County's Visa Purchasing Card. In order to participate in the Program, Bidders must submit the E=Payables Enrollment Form to the Cook County Comptroller's Office. A description of the Program is attached for informational purposes. Notwithstanding the foregoing, the County has no duty or obligation to process prompt payments to Bidders. The County reserves its right to discontinue the Program at any time. The County will not provide a bid incentive or preference to Bidders who participate in the Program.

IB-31 MINORITY AND WOMEN OWNED BUSINESS ENTERPRISE ORDINANCE

Cook County has adopted the Minority and Women Owned Business Enterprise Ordinance (the "Ordinance"). The Ordinance establishes annual participation goals for Minority and Women Owned Business Enterprises. The requirements of the Ordinance, as well as the documents the Bidder must submit are set forth in GC-19. The Bidder's failure to submit the MBE/WBE Utilization Plan, as more fully described in GC-19 shall render the Bid non-responsive.

IB-32 COOK COUNTY RECYCLED PRODUCT PROCUREMENT POLICY

Cook County has adopted the Cook County Recycled Product Procurement Policy. In accordance with the Policy, Cook County encourages the use of recycled paper and paper products, whenever practicable. The Bidder shall use recycled paper, except where the specialized nature of certain materials (such as photographs) requires otherwise, and all documents shall be printed two-sided unless two-sided printing is not practicable.

IB-33 ESTIMATED QUANTITIES

Unless expressly stated in the Specifications, Special Conditions, or Proposal page(s) any quantities stated in this Bid represent estimated usage and as such are for bid canvassing purposes only. The County reserves the right to increase or decrease quantities ordered. Nothing herein will be construed as an intent or obligation on the part of the County to purchase any goods, equipment, supplies or services beyond those determined by the County to be necessary to meet its needs.

IB-34 COALITION OF UNIONIZED PUBLIC EMPLOYEES

The Cook County Board of Commissioners has entered into an Agreement with the Coalition of Unionized Public Employees ("COUPE"). To the extent permitted by law, in the event the County either directly or indirectly through a contractor or construction manager, undertakes construction work within the trade jurisdiction of a member of COUPE, each affected coalition union shall receive fourteen (14) days written notice prior to the County's undertaking, except in the case of emergency, the County shall perform or require the performance of such work by a person, firm, or company signatory or willing to become signatory for purposes of that County project to an existing labor agreement with the coalition union or a union with the appropriate trade jurisdiction located in County of Cook.

END OF SECTION

GENERAL CONDITIONS**GENERAL CONDITIONS
BID CONTRACTS
INDEX**

<u>Section</u>	<u>Subject</u>	<u>Page</u>
GC-01	Subcontracting or Assignment of Contract or Contract Funds	GC-1
GC-02	Indemnification	GC-1
GC-03	Inspection and Responsibility	GC-1
GC-04	Payment to Contractors and Subcontractors	GC-1/2
GC-05	Prepaid Fees	GC-2
GC-06	Taxes	GC-2
GC-07	Price Reduction	GC-2
GC-08	Contractor Credits	GC-2
GC-09	Disputes	GC-2
GC-10	Contract Amendments	GC-3
GC-11	Default	GC-3
GC-12	County's Remedies	GC-3
GC-13	Contractor's Remedies	GC-4
GC-14	Delays	GC-4
GC-15	Insurance Requirements	GC-4/5
GC-16	Patents, Copyrights and Licenses	GC-5
GC-17	Compliance with Laws	GC-6
GC-18	Delivery	GC-6
GC-19	MBE/WBE Cook County Ordinance	GC-6/10
GC-20	Material Safety Data Sheet	GC-10
GC-21	Conduct of the Contractor	GC-10
GC-22	Accident Reports	GC-10
GC-23	Use of Premises	GC-10
GC-24	General Notice	GC-11

GENERAL CONDITIONS

**GENERAL CONDITIONS
 BID CONTRACTS
 INDEX**

<u>Section</u>	<u>Subject</u>	<u>Page</u>
GC-25	Termination for Convenience	GC-11
GC-26	Guarantees and Warranties	GC-11
GC-27	Standard of Contract Goods, Equipment or Supplies	GC-11
GC-28	Confidentiality and Ownership of Documents	GC-11/12
GC-29	Quantities	GC-12
GC-30	Audit; Examination of Records	GC-12
GC-31	Governing Law	GC-12
GC-32	Cooperation with Inspector General	GC-12
GC-33	Waiver	GC-12
GC-34	Entire Agreement	GC-13
GC-35	Force Majeure	GC-13
GC-36	Governmental Joint Purchasing Agreement	GC-13
GC-37	Comparable Government Procurement	GC-13
GC-38	Federal Clauses	GC-13/22
GC-39	Contract Interpretation	GC-23

GENERAL CONDITIONS**GC-01 SUBCONTRACTING OR ASSIGNMENT OF CONTRACT OR CONTRACT FUNDS**

Once awarded, this Contract shall not be subcontracted or any part thereof assigned without the express written approval of the County Chief Procurement Officer ("Chief Procurement Officer"). In no case, however, shall such approval relieve the Contractor from his obligations or change the terms of the Contract. The Contractor shall not transfer or assign any Contract funds or claims due or to become due without the advance written approval of the Chief Procurement Officer. The unauthorized subcontracting or assignment of the Contract, in whole or in part, or the unauthorized transfer or assignment of any Contract funds, either in whole or in part, or any interest therein, which shall be due or are to become due the Contractor shall have no effect on the County and are null and void.

The Contractor shall identify any and all contractors and subcontractors it intends to use in the performance of the Contract by completing the Identification of Subcontractor/Supplier/Subconsultant Form ("ISF"). All such persons shall be subject to the prior approval of the County. The Contractor will only subcontract with competent and responsible Subcontractors. The Chief Procurement Officer may require in his or her sole discretion, that the Contractor provide copies of all contracts with subcontractors.

The Contractor and its employees, contractors, subcontractors, agents and representatives are, for all purposes arising out of this Contract, independent contractors and are not employees of the County. It is expressly understood and agreed that the Contractor and its employees, contractors, subcontractors, agents and representatives shall in no event as a result of a contract be entitled to any benefit to which County employees are entitled, including, but not limited to, overtime, retirement benefits, worker's compensation benefits and injury leave or other leave benefits.

GC-02 INDEMNIFICATION

The Contractor covenants and agrees to indemnify and save harmless the County and its commissioners, officials, employees, agents and representatives, and their respective heirs, successors and assigns, from and against any and all costs, expenses, attorney's fees, losses, damages and liabilities incurred or suffered directly or indirectly from or attributable to any claims arising out of or incident to the performance or nonperformance of the Contract by the Contractor, or the acts or omissions of the officers, agents, employees, contractors, subcontractors, licensees or invitees of the Contractor. The Contractor expressly understands and agrees that any Performance Bond or insurance protection required of the Contractor, or otherwise provided by the Contractor, shall in no way limit the responsibility to indemnify the County as hereinabove provided.

GC-03 INSPECTION AND RESPONSIBILITY

The County shall have a right to inspect and approve any Contract goods, equipment, supplies or services used in carrying out this Contract and shall approve the quality and standards of all materials or completed work furnished under this Contract. Contract goods, equipment, supplies or services not complying herewith may be rejected by the Chief Procurement Officer and/or the Director and shall be replaced and/or re-performed by the Contractor at no cost to the County. Any Contract goods, equipment or supplies rejected shall be removed within a reasonable time from the premises of the County at the entire expense of the Contractor, after notice has been given by the County to the Contractor that such Contract goods, equipment or supplies have been rejected.

GC-04 PAYMENT TO CONTRACTORS AND SUBCONTRACTORS

All invoices submitted by the Contractor shall be in accordance with the cost provisions contained in the Contract Documents and shall contain a detailed description of the Deliverables (i.e., the goods, equipment, supplies or services) including the quantity of the Deliverables, for which payment is requested. All invoices for services shall include itemized entries indicating the date or time period in which the services were provided, the amount of time spent performing the services, and a detailed description of the services provided during the period of the invoice. All Contracts for services that are procured as Sole Source must also contain a provision requiring the Contractor to submit itemized records indicating the dates that services were provided, a detailed description of the work performed on each such date, and the amount of time spent performing work on each such date. All invoices shall reflect the amounts invoiced by and the amounts paid to the Contractor as of the date of the invoice. Invoices for new charges shall not include "past due" amounts, if any, which amounts must be set forth on a separate invoice. Contractor shall not be entitled to invoice the County for any late fees or other penalties.

In accordance with Section 34-177 of the Cook County Procurement Code, the County shall have a right to set off and subtract from any invoice(s) or Contract price, a sum equal to any fines and penalties, including interest, for any tax or fee delinquency and any debt or obligation owed by the Contractor to the County.

GENERAL CONDITIONS**GC-04 PAYMENT TO CONTRACTORS AND SUBCONTRACTORS (con't.)**

The Contractor acknowledges its duty to ensure the accuracy of all invoices submitted to the County for payment. By submitting the invoices, the Contractor certifies that all itemized entries set forth in the invoices are true and correct. The Contractor acknowledges that by submitting the invoices, it certifies that it has delivered the Deliverables, i.e., the goods, supplies or equipment set forth in the Contract to the Using Agency, or that it has properly performed the services set forth in the Contract. The invoice must also reflect the dates and amount of time expended in the provision of services under the Contract. The Contractor acknowledges that any inaccurate statements or negligent or intentional misrepresentations in the invoices shall result in the County exercising all remedies available to it in law and equity including, but not limited to, a delay in payment or non-payment to the Contractor, and reporting the matter to the Cook County Office of the Independent Inspector General.

When a Contractor receives any payment from the County for any supplies, equipment, goods, or services, it has provided to the County pursuant to its Contract, the Contractor must make payment to its subcontractors within 15 days after receipt of payment from the County, provided that such subcontractor has satisfactorily provided the supplies, equipment, goods or services in accordance with the Contract and provided the Contractor with all of the documents and information required of the Contractor. The Contractor may delay or postpone payment to a subcontractor when the subcontractor's supplies, equipment, goods, or services do not comply with the requirements of the Contract, the Contractor is acting in good faith, and not in retaliation for a subcontractor exercising legal or contractual rights.

GC-05 PREPAID FEES

In the event this Contract is terminated by either party, for cause or otherwise, and the County has prepaid for any goods, equipment, supplies or services to be provided pursuant to this Contract, Contractor shall refund to the County, on a prorated basis to the effective date of termination, all amounts prepaid for such goods, equipment, supplies or services not actually provided as a result of the termination. The refund shall be made within fourteen (14) days of the effective date of termination.

GC-06 TAXES

Federal Excise Tax does not apply to materials purchased by the County by virtue of Exemption Certificate No. 36-75-0038K. Illinois Retailers' Occupation Tax, Use Tax and Municipal Retailers' Occupation Tax do not apply to materials or services purchased by the County by virtue of statute. The price or prices quoted herein shall include any and all other federal and/or state, direct and/or indirect taxes which apply to this Contract. The County's State of Illinois Sales Tax Exemption Identification No. is E-9998-2013-07.

GC-07 PRICE REDUCTION

If at any time after the Contract award, Contractor makes a general price reduction in the price of any goods, equipment, supplies or services covered by the Contract, the equivalent price reduction based on similar quantities and/or considerations shall be applied to this Contract for the term of the Contract. Such price reductions shall be effective at the same time and in the same manner as the reduction in the price to customers generally.

GC-08 CONTRACTOR CREDITS

To the extent the Contractor gives credits toward future purchases from its financial incentives, discounts, value points or other benefits based on the purchase of the goods, equipment, supplies or services provided for under this Contract, such credits belong to the County and not any specific Using Agency. Contractor shall report any such credits to the Chief Procurement Officer.

GC-09 DISPUTES

Any dispute arising under the Contract between the County and Contractor shall be decided by the Chief Procurement Officer. The complaining party shall submit a written statement detailing the dispute and specifying the specific relevant Contract provision(s) to the Chief Procurement Officer. Upon request of the Chief Procurement Officer, the party complained against shall respond to the complaint in writing within five days of such request. The Chief Procurement Officer will reduce his decision to writing and mail or otherwise furnish a copy thereof to the Contractor and Director. Dispute resolution as provided herein shall be a condition precedent to any other action at law or in equity. Notwithstanding a dispute, Contractor shall continue to discharge all its obligations, duties and responsibilities set forth in the Contract during any dispute resolution proceeding unless otherwise agreed to by the County in writing.

GENERAL CONDITIONS

GC-10 CONTRACT AMENDMENTS

The parties may during the term of the Contract make amendments to the Contract but only as provided in this section. Such amendments shall only be made by mutual agreement in writing.

In the case of Contracts not approved by the Board, the Chief Procurement Officer may amend a contract provided that the total cost of all such amendments does not increase the total amount of the Contract beyond \$200,000. Such action may only be made with the advance written approval of the Chief Procurement Officer. If the amendment increases the total award amount beyond \$200,000, then Board approval will be required.

No Using Agency or employee thereof has authority to make any amendments to the Contract. Any modifications or amendments to the Contract made without the express written approval of the Chief Procurement Officer is void and unenforceable.

Contractor is hereby notified that, except for amendments which are made in accordance with this GC-10 Modifications and Amendments, no Using Agency or employee thereof has authority to make any modification or amendment to the Contract.

GC-11 DEFAULT

Contractor shall be in default hereunder in the event of a material breach by Contractor of any term or condition of this Contract where Contractor has failed to cure such breach within ten (10) days after written notice of breach is given to Contractor by the County, setting forth the nature of such breach.

A material breach of the contract by the Contractor includes but is not limited to the following:

1. Failure to begin performance under the Contract within the specified time;
2. Failure to perform under the Contract with sufficient personnel, equipment, or materials to ensure completion of said performance within the specified time or failure to assign qualified personnel to ensure completion within the specified time;
3. Performance of the Contract in an unsatisfactory manner;
4. Refusal to perform services deemed to be defective or unsuitable;
5. Discontinuance of performance of Contractor's obligations under the Contract or the impairment or the reasonable progress of performance;
6. Becoming insolvent, being declared bankrupt or committing any act of bankruptcy or insolvency;
7. Any assignment of the Contract for the benefit of creditors;
8. Any cause whatsoever which impairs performance in an acceptable manner; or
9. Any other material breach of any term or condition of the Contract.

County shall be in default hereunder if any material breach of the Contract by the County occurs which is not cured by the County within forty-five (45) days after written notice of breach has been given by Contractor to the County, setting forth the nature of such breach.

GC-12 COUNTY'S REMEDIES

If the Contractor fails to remedy a material breach during the ten (10) day cure period pursuant to General Condition GC-11, Default, the County shall have the right to terminate the Contract provided, however, that the County shall give Contractor prior written notice of its intent to terminate. Following notice of breach to Contractor, the County reserves the right to withhold payments owed to Contractor until such time as Contractor has cured the breach which is the subject matter of the notice. In addition, the County shall have the right to pursue all remedies in law or equity.

GENERAL CONDITIONS

GC-13 CONTRACTOR'S REMEDIES

If the County has been notified of breach and fails to remedy the breach during the forty-five (45) day cure period pursuant to General Condition GC-11, Default, the Contractor shall have the right to terminate this Contract providing, however, that Contractor shall give the County thirty (30) days prior written notice of termination. Contractor shall have the right to pursue all remedies available in law or equity. In all cases the Contractor's damages shall be those provable damages not to exceed the value of the Contract as awarded by the Cook County Board of Commissioners or the Chief Procurement Officer.

GC-14 DELAYS

Contractor agrees that no charges or claims for damages shall be made by Contractor for any delays or hindrances from any cause whatsoever related to the performance of the Contract.

GC-15 INSURANCE REQUIREMENTS

Waiver of Subrogation

All insurance policies shall contain a Waiver of Subrogation Endorsement in favor of Cook County.

Insurance Requirements of the Contractor

No later than the effective date of this Contract, the Contractor, at its cost, shall secure and maintain at all times, unless specified otherwise, until completion of the term of this Contract the insurance specified below. Nothing contained in these insurance requirements is to be construed as limiting the extent of the Contractor's responsibility for payment of damages resulting from its performance of this Contract. The insurance purchased and maintained by the Contractor shall be primary and not excess or pro rata to any other insurance issued to the County. Contractor shall require all subcontractors to provide the insurance required in this Contract, or Contractor may provide the coverages for the subcontractors. All subcontractors are subject to the same insurance requirements as Contractor except paragraph (d) Excess Liability or unless specified otherwise. The Cook County Department of Risk Management maintains the right to modify, delete, alter or change these requirements.

1. Coverages

(a) **Workers Compensation Insurance**

Workers' Compensation shall be in accordance with the laws of the State of Illinois or any other applicable jurisdiction.

The Workers Compensation policy shall also include the following provisions:

Employers' Liability coverage with a limit of:

- (1) \$1,000,000 each Accident
- (2) \$1,000,000 each Employee
- (3) \$1,000,000 Policy Limit for Disease

(b) **Commercial General Liability Insurance**

The Commercial General Liability shall be on an occurrence form basis to cover bodily injury and property damage including loss of use.

The General Liability limits shall not be less than \$1,000,000 per occurrence and \$2,000,000 aggregate combined single limit for bodily injury and property damage. The General Liability policy shall include, without limitation the following coverages:

- (1) All premises and operations;
- (2) Contractual Liability;
- (3) Products/Completed Operations;
- (4) Severability of interest/separation of insureds clause.

(c) **Automobile Liability Insurance**

When any vehicles are used in the performance of the Contract, Contractor shall secure Automobile Liability Insurance to cover all owned, non-owned and hired automobiles, trucks and trailers. The limits of liability shall not be less than the following:

GENERAL CONDITIONS

- (1) Liability - All Autos: Bodily Injury & Property Damage - \$1,000,000 per Occurrence
- (2) Uninsured/Motorists: Per Illinois Requirements

(d) **Umbrella/Excess Liability Insurance**

In addition to the coverages and limits specified above, Contractor shall secure and maintain a limit of liability no less than \$1,000,000 each occurrence for all liability.

2. Additional requirements

(a) **Additional Insured**

Cook County, its officials, employees and agents shall be named as additional insureds under the Commercial General Liability policy and Automobile Liability policy. Contractor's insurance shall be primary and non-contributory with any insurance maintained by Cook County. Any insurance or self-insurance maintained by Cook County shall be excess of the Contractor's insurance and shall not contribute with it. The full policy limits and scope of protection shall apply to Cook County as an additional insured even if they exceed the minimum insurance limits specified above.

(b) **Qualification of Insurers**

All insurance companies providing coverage shall be licensed or approved by the Department of Insurance, State of Illinois, and shall have a financial rating no lower than (A-) VII as listed in A.M. Best's Key Rating Guide, current edition or interim report. Companies with ratings lower than (A-) VII will be acceptable only upon written consent of the Cook County Department of Risk Management.

(c) **Insurance Notices**

All policies of insurance which may be required under terms of this Contract shall be endorsed to provide that the insurance company shall notify the Cook County Office of the Chief Procurement Officer, 69 W Washington St., Floor 30, Chicago, Illinois 60602 at least 30 days prior to the effective date of any cancellation or modification of such policies. Prior to the date on which Contractor commences performance of its part of the work, Contractor shall furnish to the County certificates of insurance maintained by Contractor.

In no event shall any failure of the County to receive Certificates of Insurance required hereof or to demand receipt of such Certificates of Insurance be construed as a waiver of Contractor's obligations to obtain insurance pursuant to these insurance requirements.

GC-16 PATENTS, COPYRIGHTS AND LICENSES

Contractor agrees to hold harmless and indemnify the County, its officials, agents, employees and affiliates from and defend, as permitted by Illinois law, at its own expense (including reasonable attorneys', accountants' and consultants' fees), any suit or proceeding brought against County based upon a claim that the ownership and/or use of equipment, hardware and software or any part thereof utilized in performing Contractor's services constitutes an infringement of any patent, copyright or license or any other intellectual property right.

In the event the use of any equipment, hardware or software or any part thereof is enjoined, Contractor with all reasonable speed and due diligence shall provide or otherwise secure for County, at the Contractor's election, one of the following: the right to continue use of the equipment, hardware or software; an equivalent system having the Specifications as provided in this Contract; or to modify the system or its component parts so that it becomes non-infringing while performing in a substantially similar manner to the original system, meeting the Specifications of this Contract.

GC-17 COMPLIANCE WITH LAWS

The Contractor shall observe and comply with the laws, ordinances, regulations and codes of the Federal, State, County and other local government agencies which may in any manner affect the performance of the Contract, including but not limited to those County Ordinances set forth in the Certifications, Affidavits or EDS attached hereto and incorporated herein. Assurance of compliance with this requirement by the Contractor's employees, agents or subcontractors shall be the responsibility of the Contractor.

GENERAL CONDITIONS

The Contractor shall secure and pay for all federal, state and local licenses, permits and fees required in order to perform this Contract.

GC-18 DELIVERY

All Contract goods, equipment or supplies shipped to the County shall be shipped F.O.B., DESTINATION, FREIGHT PREPAID. Arrangements shall be made in advance by the Contractor in order that the County may arrange for receipt of the materials.

Truck deliveries will be accepted before 3:00 P.M. on weekdays only. No deliveries will be accepted on Saturdays, Sundays or County Holidays. The County is not responsible for delivery delays due to waiting times for loading and unloading at delivery locations.

The quantity of Contract goods, equipment or supplies based on weight that are delivered by truck will be ascertained from a weight certificate issued by a duly licensed Public Weight-Master. In the case of delivery by rail, weight will be ascertained from bill of lading from originating line, but the County reserves the right to re-weight at the nearest available railroad scale.

The County reserves the right to add new delivery locations or delete previously listed delivery locations as required during the Contract period. The only restriction regarding the County's right to add new delivery locations shall be that any new or additional location shall be within the geographical boundaries of the County of Cook.

GC-19 MINORITY AND WOMEN BUSINESS ENTERPRISES
COOK COUNTY ORDINANCE CHAPTER 34, DIVISION 8 SECTION 34-260 to SECTION 34-300

I. POLICY AND GOALS

A. It is the policy of the County of Cook to prevent discrimination in the award of or participation in County Contracts and to eliminate arbitrary barriers for participation in such Contracts by local businesses certified as a Minority Business Enterprise (MBE) and Women-owned Business Enterprise (WBE) as both prime and sub-contractors. In furtherance of this policy, the Cook County Board of Commissioners has adopted a Minority- and Women-owned Business Enterprise Ordinance (the "Ordinance") which establishes annual goals for MBE and WBE participation as outlined below:

Contract Type	Goals	
	MBE	WBE
Goods and Services	25%	10%
Construction	24%	10%
Professional Services	35% Overall	

B. **The County shall set contract-specific goals, based on the availability of MBEs and WBEs that are certified to provide commodities or services specified in this solicitation document. The MBE/WBE participation goals for each Contract are stated in the Special Conditions.** A Bid, Quotation, or Proposal shall be rejected if the County determines that it fails to comply with this General Condition in any way, including but not limited to: (i) failing to state an enforceable commitment to achieve for this contract the identified MBE/WBE Contract goals; or (ii) failing to include a Petition for Reduction/Waiver, which states that the goals for MBE/WBE participation are not attainable despite the Bidder or Proposer Good Faith Efforts, and explains why. If a Bid, Quotation, or Proposal is rejected, then a new Bid, Quotation, or Proposal may be solicited if the public interest is served thereby.

GC-19 MINORITY AND WOMEN BUSINESS ENTERPRISES
COOK COUNTY ORDINANCE CHAPTER 34, DIVISION 8 SECTION 34-260 to SECTION 34-300 (con't.)

C. To the extent that a Bid, Quotation, or Proposal includes a Petition for Reduction/Waiver that is approved by the Office of Contract Compliance, the Contract specific MBE and WBE participation goals may be achieved by the proposed Bidder or Proposer's status as an MBE or WBE; by the Bidder or Proposer's enforceable joint-venture agreement with one or more MBEs and/or WBEs; by the Bidder or Proposer entering into one or more enforceable subcontracting agreements with one or more MBE and WBE; by the Bidder or Proposer establishing and carrying out an enforceable mentor/protégé agreement with one or more MBE and WBE; by the Bidder or Proposer actively engaging the Indirect Participation of one or more MBE and WBE in other aspects of its business; or by any

GENERAL CONDITIONS

combination of the foregoing, so long as the Utilization Plan evidences a commitment to meet the MBE and WBE Contract goals set forth in (B) above, as approved by the Office of Contract Compliance.

- D. A single Person, as defined in the Procurement Code, may not be utilized as both an MBE and a WBE on the same Contract, whether as a contractor, subcontractor or supplier.
- E. Unless specifically waived in the Bid or Proposal Documents, this General Condition, GC-19; the Ordinance; and the policies and procedures promulgated thereunder shall govern. If there is a conflict between this GC-19 and the Ordinance or the policies and procedures, the Ordinance shall control.
- F. A Contractor's failure to carry out its commitment regarding MBE and WBE participation in the course of the Contract's performance may constitute a material breach of the Contract. If such breach is not appropriately cured, it may result in withholding of payments under the Contract, contractual penalties, disqualification and any other remedy provided for in Division 4 of the Procurement Code at law or in equity.

II. REQUIRED BID OR PROPOSAL SUBMITTALS

A Bidder or Proposer shall document its commitment to meeting the Contract specific MBE and WBE participation goals by submitting a Utilization Plan with the Bid or Proposal. The Utilization Plan shall include (1) one or more Letter(s) of Intent from the relevant MBE and WBE firms; and (2) current Letters of Certification as an MBE or WBE. Alternatively, the Bidder or Proposer shall submit (1) a written Petition for Reduction/Waiver with the Bid, Quotation or Proposal, which documents its preceding Good Faith Efforts and an explanation of its inability to meet the goals for MBE and WBE participation. The Utilization Plan shall be submitted at the time that the bid or proposal is due. **Failure to include a Utilization Plan will render the submission not Responsive and shall be cause for the CPO to reject the Bid or Proposal.**

A. MBE/WBE Utilization Plan

Each Bid or Proposal shall include a complete Utilization Plan, as set forth on Form 1 of the M/WBE Compliance Forms. The Utilization Plan shall include the name(s), mailing address, email address, and telephone number of the principal contact person of the relevant MBE and WBE firms. If the Bidder or Proposer submits a Bid or Proposal, and any of their subcontractors, suppliers or consultants, are certified MBE or WBE firms, they shall be identified as an MBE or WBE within the Utilization Plan.

1. Letter(s) of Intent

Except as set forth below, a Bid or Proposal shall include, as part of the Utilization Plan, one or more Letter(s) of Intent, as set forth on Form 2 of the M/WBE Compliance Forms, executed by each MBE and WBE and the Bidder or Proposer. The Letter(s) of Intent will be used to confirm that each MBE and WBE shall perform work as a subcontractor, supplier, joint venture, or consultant on the Contract. Each Letter of Intent shall indicate whether and the degree to which the MBE or WBE will provide goods or services directly or indirectly during the term of the Contract. The box for direct participation shall be marked if the proposed MBE or WBE will provide goods or services directly related to the scope of the Contract. The box for Indirect participation shall be marked if the proposed MBE or WBE will not be directly involved in the Contract but will be utilized by the Bidder or Proposer for other services not related to the Contract. Indirect Participation shall not be counted toward the participation goal. Each Letter of Intent shall accurately detail the work to be performed by the relevant MBE or WBE firm, the agreed dollar amount, the percentage of work, and the terms of payment.

GC-19 MINORITY AND WOMEN BUSINESS ENTERPRISES
COOK COUNTY ORDINANCE CHAPTER 34, DIVISION 8 SECTION 34-260 to SECTION 34-300 (con't.)

Failure to include Letter(s) of Intent will render the submission not Responsive and shall be cause for the CPO to reject the Bid or Proposal.

All Bids and Proposals must conform to the commitments made in the corresponding Letter(s) of Intent, as may be amended through change orders.

The Contract Compliance Director may at any time request supplemental information regarding Letter(s) of Intent, and such information shall be furnished if the corresponding Bid or Proposal is to be deemed responsive.

GENERAL CONDITIONS

2. Letter(s) of Certification

Only current Letter(s) of Certification from one of the following entities may be accepted as proof of certification for MBE/WBE status, provided that Cook County’s requirements for certification are met:

- County of Cook
- City of Chicago

Persons that are currently certified by the City of Chicago in any area other than Construction/Public Works shall also complete and submit a MBE/WBE Reciprocal Certification Affidavit along with a current letter of certification from the City of Chicago. This Affidavit form can be downloaded from www.cookcountyil.gov/contractcompliance.

The Contract Compliance Director may reject the certification of any MBE or WBE on the ground that it does not meet the requirements of the Ordinance, or the policies and rules promulgated thereunder.

3. Joint Venture Affidavit

In the event a Bid or Proposal achieves MBE and/or WBE participation through a Joint Venture, the Bid or Proposal shall include the required Joint Venture Affidavit, which can be downloaded from www.cookcountyil.gov/contractcompliance. The Joint Venture Affidavit shall be submitted with the Bid or Proposal, along with current Letter(s) of Certification.

B. Petition for Reduction/Waiver

In the event a Bid or Proposal does not meet the Contract specific goals for MBE and WBE participation, the Bid or Proposal shall include a Petition for Reduction/Waiver, as set forth on Form 3. The Petition for Reduction/Waiver shall be supported by sufficient evidence and documentation to demonstrate the Bidder or Proposer’s Good Faith Efforts in attempting to achieve the applicable MBE and WBE goals, and its inability to do so despite its Good Faith Efforts.

Failure to include Petition for Reduction/Waiver will render the submission not Responsive and shall be cause for the CPO to reject the Bid or Proposal.

III. REDUCTION/WAIVER OF MBE/WBE GOALS

A. Granting or Denying a Reduction/Waiver Request.

1. The adequacy of the Good Faith Efforts to utilize MBE and WBE firms in a Bid or Proposal will be evaluated by the CCD under such conditions as are set forth in the Ordinance, the policies and rules promulgated thereunder, and in the “Petition for Reduction/Waiver of MBE/WBE Participation Goals” – Form 3 of the M/WBE Compliance Forms.
2. With respect to a Petition for Reduction/Waiver, the sufficiency or insufficiency of a Bidder or Proposer’s Good Faith Efforts shall be evaluated by the CCD as of the date upon which the corresponding Bid or Proposal was due.

GC-19 MINORITY AND WOMEN BUSINESS ENTERPRISES
COOK COUNTY ORDINANCE CHAPTER 34, DIVISION 8 SECTION 34-260 to SECTION 34-300 (con’t.)

3. The Contract Compliance Director or his or her duly authorized Waiver Committee may grant or deny the
4. Petition for Reduction/Waiver based upon factors including but not limited to: (a) whether sufficient qualified MBE and WBE firms are unavailable despite good faith efforts on the part of the Bidder or Proposer; (b) the degree to which specifications and the reasonable and necessary requirements for performing the Contract make it impossible or economically infeasible to divide the Contract into sufficiently small tasks or quantities so as to enable the Bidder or Proposer to utilize MBE and WBE firms in accordance with the applicable goals; (c) the degree to which the prices or prices required by any potential MBE or WBE are more that 10% above competitive levels; and (d) such other factors as are determined relevant by the Contract Compliance Director or the duly authorized Waiver Committee.

GENERAL CONDITIONS

5. If the Contract Compliance Director or the duly authorized Waiver Committee determines that the Bidder or Proposer has not demonstrated sufficient Good Faith Efforts to meet the applicable MBE and WBE goals, the Contract Compliance Director or the duly authorized Waiver Committee may deny a Petition for Reduction/Waiver, declare the Bid or Proposal non-responsive, and recommend rejection of the Bid, Quotation, or Proposal.

IV. CHANGES IN CONTRACTOR'S UTILIZATION PLAN

- A. A Contractor, during its performance of the Contract, may not change the original MBE or WBE commitments specified in the relevant Utilization Plan, including but not limited to, terminating a MBE or WBE Contract, reducing the scope of the work to be performed by a MBE/WBE, or decreasing the price to a MBE/WBE, except as otherwise provided by the Ordinance and according to the policies and procedures promulgated thereunder.
- B. Where a Person listed under the Contract was previously considered to be a MBE or WBE but is later found not to be, or work is found not to be creditable toward the MBE or WBE goals as stated in the Utilization Plan, the Contractor shall seek to discharge the disqualified enterprise, upon proper written notification to the Contract Compliance Director, and make every effort to identify and engage a qualified MBE or WBE as its replacement. Failure to obtain an MBE or WBE replacement within 30 business days of the Contract Compliance Director's written approval of the removal of a purported MBE or WBE may result in the termination of the Contract or the imposition of such remedy authorized by the Ordinance, unless a written Petition for Reduction/Waiver is granted allowing the Contractor to award the work to a Person that is not certified as an MBE or WBE.

V. NON-COMPLIANCE

If the CCD determines that the Contractor has failed to comply with its contractual commitments or any portion of the Ordinance, the policies and procedures promulgated thereunder, or this GC-19, the Contract Compliance Director shall notify the Contractor of such determination and may take any and all appropriate actions as set forth in the Ordinance or the policies and procedures promulgated thereunder which includes but is not limited to disqualification, penalties, withholding of payments or other remedies in law or equity.

VI. REPORTING/RECORD-KEEPING REQUIREMENTS

The Contractor shall comply with the reporting and record-keeping requirements in the manner and time established by the Ordinance, the policies and procedure promulgated thereunder, and the Contract Compliance Director. Failure to comply with such reporting and record-keeping requirements may result in a declaration of Contract default. Upon award of a Contract, a Contractor shall acquire and utilize all Cook County reporting and record-keeping forms and methods which are made available by the Office of Contract Compliance. MBE and WBE firms shall be required to verify payments made by and received from the prime contractor.

GC-19 MINORITY AND WOMEN BUSINESS ENTERPRISES
COOK COUNTY ORDINANCE CHAPTER 34, DIVISION 8 SECTION 34-260 to SECTION 34-300 (con't.)

VII. EQUAL EMPLOYMENT OPPORTUNITY

Compliance with MBE and WBE requirements will not diminish or supplant other legal Equal Employment Opportunity and Civil Rights requirements that relate to contractor and subcontractor obligations.

Any questions regarding this section should be directed to:

Contract Compliance Director
Cook County
161 N. Clark Street, Suite 2300
Chicago, Illinois 60601
(312) 603-5502

GC-20 MATERIAL DATA SAFETY SHEET

Where required under the Illinois "Toxic Substance Disclosure to Employees Act", Illinois Compiled Statutes, 820 ILCS 255/1, Contractor shall submit with each delivery of Contract goods, equipment or supplies a Material Data Safety Sheet.

GENERAL CONDITIONS

GC-21 CONDUCT OF THE CONTRACTOR

The Contractor agrees to inform the County on a timely basis of all of the Contractor's interests, if any, which are or which the Contractor reasonably believes may be incompatible with any interest of the County. The Contractor shall take notice of and comply with the Illinois Lobbyist Registration Act, 25 ILCS 170. The Contractor shall not use for personal gain or make other improper use of privileged information which is acquired in connection with the Contract.

GC-22 ACCIDENT REPORTS

The Chief Procurement Officer and Director shall be given written notification within twenty-four (24) hours of any occurrence, on the site or otherwise, which pertains in any way to the performance of this Contract and involves the Contractor's personnel, or those of any of his subcontractors or others whether said occurrence be in the nature of bodily injury to employees or third parties or property damage.

The report shall include the name of person(s) injured, name of his employer, date, time and location of occurrence, extent of injury and/or damage, name(s) of eyewitnesses, and who treated the person(s) for injuries sustained, and such other information as may be relevant. The Contractor shall notify the local police of any occurrence requiring an official police record. The accident report should indicate whether the police were notified and, if so, the number of the police report.

GC-23 USE OF PREMISES

Contractor shall confer with the Director to ascertain full knowledge of all rules and regulations of the County facilities relative to this Contract and shall comply therewith. The Contractor shall confine the operations of its employees to the limits indicated by laws, ordinances, permits and/or direction of the Director and shall not encumber the premises with materials or debris. The Contractor shall not load or permit any part of the structure to be loaded with a weight that will endanger its structural integrity.

The County reserves the right to prohibit any person from entering any County facility for any reason. All subcontractors, agents and employees of the Contractor shall be accountable to the Director while on any County property and shall abide by all security regulations imposed by the County.

GC-24 GENERAL NOTICE

All notices required pursuant to this Contract shall be in writing and addressed to the parties at their respective addresses set forth below. All such notices shall be deemed duly given if hand delivered or if deposited in the United States mail, registered or certified, return receipt requested. Notice as provided herein does not waive service of summons or process.

TO THE COUNTY:

Chief Procurement Officer
County of Cook
161 N. Clark Street, Suite 2300
Chicago, Illinois 60601
(Reference County Contract Number)

TO THE CONTRACTOR:

At address provided in its bid document or as otherwise indicated in writing to County.

GC-25 TERMINATION FOR CONVENIENCE

The County may terminate this Contract, or any portion, at any time by notice in writing from the County to the Contractor. Unless otherwise stated in the notice, the effective date of such termination shall be three business days after the date the notice of termination is mailed by the County. If the County elects to terminate the Contract in full, unless otherwise specified in the notice of termination, the Contractor shall immediately cease performance and shall promptly tender to the County all work products, reviews, recommendations, reports, documents and analyses, whether completed or in process. If the County elects to terminate the Contract in part, unless otherwise specified in the notice of partial termination, the Contractor shall immediately cease performance of those portions of the Contract which are terminated and shall promptly tender to the County all work products, reviews, recommendations, reports, documents

GENERAL CONDITIONS

and analyses relating to said portions of the Contract, whether completed or in process. Contractor shall refrain from incurring any further costs with respect to portions of the Contract which are terminated except as specifically approved by the Chief Procurement Officer. The Contractor shall not invoice the County for any goods, equipment, supplies or services provided after the effective date of termination.

GC-26 GUARANTEES AND WARRANTIES

Unless otherwise stated herein, all guarantees and warranties required shall be furnished by the Contractor and shall be delivered to the Director before final payment on the Contract is issued. The Contractor agrees that the Contract goods, equipment, supplies or services to be furnished shall be covered by the most favorable commercial warranties the Contractor gives to any customer for the same or substantially similar Contract goods, equipment, supplies or services and that the rights and remedies so provided are in addition to and do not limit any rights afforded to County.

GC-27 STANDARD OF CONTRACT GOODS, EQUIPMENT OR SUPPLIES

Only new, originally manufactured Contract goods, equipment or supplies will be accepted by the County. The County will not accept any Contract goods, equipment or supplies that have been refurbished, rebuilt, restored or renovated in any manner. In addition, experimental materials will not be acceptable. Contract goods, equipment or supplies not produced by regular production methods and/or which have not been offered for sale to the public through accepted industry trade channels for a reasonable period of time prior to the offering of the proposal, will be considered experimental.

GC-28 CONFIDENTIALITY AND OWNERSHIP OF DOCUMENTS

Contractor acknowledges and agrees that information regarding this Contract is confidential and shall not be disclosed, directly, indirectly or by implication, or be used by Contractor in any way, whether during the term of this Contract or at any time thereafter, except solely as required in the course of Contractor's performance of the Contract. Contractor shall comply with the applicable privacy laws and regulations affecting the County and will not disclose any of County's records, materials, or other data to any third party. Contractor shall not have the right to compile and distribute statistical analyses and reports utilizing data derived from information or data obtained from County without the prior written approval of County. In the event such approval is given, any such reports published and distributed by Contractor shall be furnished to County without charge.

GC-28 CONFIDENTIALITY AND OWNERSHIP OF DOCUMENTS (con't.)

All documents, data, studies, reports, work product or product created as a result of the performance of this Contract shall be the property of the County of Cook. It shall be a breach of this Contract for the Contractor to reproduce or use, any documents, data, studies, report, work product or product obtained from the County of Cook or created hereby for its own purposes or to be copied and used by any third party. During the performance of the services herein provided for, the Contractor shall be responsible of any loss or damage to the County's documents while they are in the Contractor's possession, and any such document lost or damaged shall be restored at the expense of the Contractor.

GC-29 QUANTITIES

The quantities of materials required for the performance of the Contract are estimates for the purpose of determining an approximate total Contract amount and may not be the actual quantities required during the term of the Contract. The County reserves the right to increase or decrease the quantities at the Contract price, to correspond to the actual needs of the County. The County will be obligated to order and pay for only such quantities as are from time to time ordered, delivered, and accepted on purchase orders issued by the County.

GC-30 AUDIT; EXAMINATION OF RECORDS

The Contractor agrees that the Cook County Auditor or any of its duly authorized representatives shall, until expiration of three (3) years after the final payment under the Contract, have access and the right to examine any books, documents, papers, canceled checks, bank statements, purveyor's and other invoices, and records of the Contractor related to the Contract, or to Contractor's compliance with any term, condition or provision thereof. The Contractor shall be responsible for establishing and maintaining records sufficient to document the costs associated with performance under the terms of this Contract.

The Contractor further agrees that it shall include in all of its subcontracts hereunder a provision to the effect that the subcontractor agrees that the Cook County Auditor or any of its duly authorized representatives shall, until expiration of three (3) years after final payment under the subcontract, have access and the right to examine any books,

GENERAL CONDITIONS

documents, papers, canceled checks, bank statements, purveyor's and other invoices and records of such subcontractor involving transactions relating to the subcontract, or to such subcontractor's compliance with any term, condition or provision thereunder or under the Contract.

In the event the Contractor receives payment under the Contract, reimbursement for which is later disallowed by the County, the Contractor shall promptly refund the disallowed amount to the County on request, or at the County's option, the County may credit the amount disallowed from the next payment due or to become due to the Contractor under any contract with the County.

GC-31 GOVERNING LAW

This Contract shall be governed by and construed under the laws of the State of Illinois. The Contractor irrevocably agrees that, subject to the County's sole and absolute election, any action or proceeding in any way, manner or respect arising out of the Contract, or arising from any dispute or controversy in connection with or related to the Contract, shall be litigated only in courts within the Circuit Court of Cook County, State of Illinois, and the Contractor consents and submits to the jurisdiction thereof. In accordance with these provisions, Contractor waives any right it may have to transfer or change the venue of any litigation brought against it by the County pursuant to this Contract.

GC-32 COOPERATION WITH INSPECTOR GENERAL

Contractors, subcontractors, licensees, grantees or persons or businesses who have a County contract, grant, license, or certification of eligibility for County contracts shall abide by all of the applicable provisions of the Office of the Independent Inspector General Ordinance (Section 2-281 et. seq. of the Cook County Code of Ordinances). Failure to cooperate as required may result in monetary and/or other penalties.

GC-33 WAIVER

No term or provision of this Contract shall be deemed waived and no breach consented to unless such waiver or consent shall be in writing and signed by the party claimed to have waived or consented. The waiver of any such provision shall be strictly limited to the identified term or provision.

GC-34 ENTIRE CONTRACT

It is expressly agreed that the provisions set forth in this Contract constitute all the understandings and agreements between the parties. Any prior agreements, promises, negotiations, or representations not expressly set forth in this Contract are of no force and effect.

GC-35 FORCE MAJEURE

Neither Contractor nor County shall be liable for failing to fulfill any obligation under this Contract if such failure is caused by an event beyond such party's reasonable control and which is not caused by such party's fault or negligence. Such events shall be limited to acts of God, acts of war, fires, lightning, floods, epidemics, or riots.

GC-36 GOVERNMENTAL JOINT PURCHASING AGREEMENT

Pursuant to Section 4 of the Illinois Governmental Joint Purchasing Act (30 ILCS 525) and the Joint Purchase Agreement approved by the Cook County Board of Commissioners (April 9, 1965), other units of government may purchase goods, supplies, equipment or services under this Contract.

In the event that other agencies participate in a joint procurement, the County reserves the right to renegotiate the price to accommodate the larger volume.

GC-37 COMPARABLE GOVERNMENT PROCUREMENT

As permitted by the County of Cook, other government entities, if authorized by law, may wish to also purchase the goods, supplies, services or equipment under the same terms and conditions contained in this Contract (i.e., comparable government procurement). Each entity wishing to reference this Contract must have prior authorization from the County of Cook and the Contractor. If such participation is authorized, all purchase orders will be issued directly from and shipped directly to the entity requiring the goods, supplies, equipment or services. The County shall not be held responsible for any orders placed, deliveries made or payment for the goods, supplies, equipment or services ordered by these entities. Each entity reserves the right to determine the amount of goods, supplies, equipment or services it wishes to purchase under this Contract.

GENERAL CONDITIONS**GC-38 FEDERAL CLAUSES**

The following provisions apply to all Contracts which are funded in whole or in part with federal funds.

1. Interest of Members of or Delegates to the United States Congress
In accordance with 41 U.S.C. § 22, the Contractor agrees that it will not admit any member of or delegate to the United States Congress to any share or part of the Contract or any benefit derived therefrom.

The following provisions apply to all Contracts which are funded in whole or in part with federal funds.

1. Interest of Members of or Delegates to the United States Congress

In accordance with 41 U.S.C. § 22, the Contractor agrees that it will not admit any member of or delegate to the United States Congress to any share or part of the Contract or any benefit derived therefrom.
2. False or Fraudulent Statements and Claims
 - (a) The Contractor recognizes that the requirements of the Program Fraud Civil Remedies Act of 1986, as amended, 49 U.S.C. §§ 3081 et seq and U.S. DOT regulations, "Program Fraud Civil Remedies," 49 C.F.R. Part 31, apply to its actions pertaining to the Contract. Accordingly, by signing the Contract, the Contractor certifies or affirms the truthfulness and accuracy of any statement it has made, it makes, or it may make pertaining to the Contract, including without limitation any invoice for its services. In addition to other penalties that may be applicable, the Contractor also acknowledges that if it makes a false, fictitious, or fraudulent claim, statement, submission, or certification, the Federal Government reserves the right to impose the penalties of the Program Fraud Civil Remedies Act of 1986, as amended, on the Contractor to the extent the Federal Government deems appropriate.

GC-38 FEDERAL CLAUSES (con't.)

- (b) The Contractor also acknowledges that if it makes a false, fictitious, or fraudulent claim, statement, submission, or certification to the County or Federal Government in connection with an urbanized area formula project financed with Federal assistance authorized by 49 U.S.C. § 5307, the Government reserves the right to impose on the Contractor the penalties of 18 U.S.C. § 1001 and 49 U.S.C. § 5307(n)(1), to the extent the Federal Government deems appropriate.
3. Federal Interest in Patents
 - (a) **General.** If any invention, improvement, or discovery of the Contractor is conceived or first actually reduced to practice in the course of or under the Contract, and that invention, improvement, or discovery is patentable under the laws of the United States of America or any foreign country, the Contractor agrees to notify County immediately and provide a detailed report.
 - (b) **Federal Rights.** Unless the Federal Government later makes a contrary determination in writing, the rights and responsibilities of the County, Contractor, and the Federal Government pertaining to that invention, improvement, or discovery will be determined in accordance with applicable Federal laws and regulations, including any waiver thereof. Unless the Federal Government later makes a contrary determination in writing, the Contractor agrees that, irrespective of its status or the status of any subcontractor at any tier (e.g., a large business, small business, non-profit organization, institution of higher education, individual), the Contractor agrees it will transmit to the Federal Government those rights due the Federal Government in any invention resulting from the contract.
4. Federal Interest in Data and Copyrights
 - (a) **Definition.** The term "subject data" used in this section means recorded information, whether or not copyrighted, that is delivered or specified to be delivered under the Contract. Examples include, but are not limited, to: computer software, engineering drawings and associated lists, specifications,

GENERAL CONDITIONS

standards, process sheets, manuals, technical reports, catalog item identifications, and related information. The term "subject data" does not include financial reports, cost analyses, and similar information incidental to Contract administration.

- (b) Federal Restrictions. The following restrictions apply to all subject data first produced in the performance of the Contract. Except as provided in the Contract and except for its own internal use, the Contractor may not publish or publicly reproduce subject data in whole or in part, or in any manner or form, nor may the Contractor authorize others to do so, without the written consent of the County and the Federal Government, until such time as the Federal Government may have either released or approved the release of such data to the public.
- (c) Federal Rights in Data and Copyrights. In accordance with subparts 34 and 36 of the Common Rule, the County and the Federal Government reserve a royalty-free, non-exclusive and irrevocable license to reproduce, publish, or otherwise use, and to authorize others to use, for County or Federal Government purposes, the types of subject data described below. Without the copyright owner's consent, the County and Federal Government may not extend their license to other parties.
 - (1) Any subject data developed under the contract or subagreement financed by a federal Grant Agreement or Cooperative Agreement, whether or not a copyright has been obtained; and
 - (2) Any rights of copyright which the Contractor purchases ownership with Federal assistance.

GC-38 FEDERAL CLAUSES (con't.)

- (d) Special Federal Rights for Planning Research and Development Projects. When the Federal Government provides financial assistance for a planning, research, development, or demonstration project, its general intention is to increase public knowledge, rather than limit the benefits of the project to participants in the project. Therefore, unless the Federal Government determines otherwise, the Contractor on a planning, research, development, or demonstration project agrees that, in addition to the rights in data and copyrights set forth above, the County or Federal Government may make available to any third party either a license in the copyright to the subject data or a copy of the subject data. If the project is not completed for any reason whatsoever, all data developed under the project will become subject data and will be delivered as the County or Federal Government may direct. This subsection, however, does not apply to adaptations of automatic data processing equipment or previously existing software programs for the County's use whose costs are financed with Federal transportation funds for capital projects.
- (e) Hold Harmless. Unless prohibited by state law, upon request by the County or the Federal Government, the Contractor agrees to indemnify, save, and hold harmless the County and the Federal Government and their officers, agents, and employees acting within the scope of their official duties against any liability, including costs and expenses, resulting from any willful or intentional violation by the Contractor of proprietary rights, copyrights, or right of privacy, arising out of the publication, translation, reproduction, delivery, use, or disposition of any data furnished under the Contract. The Contractor will not be required to indemnify the County or Federal Government for any such liability arising out of the wrongful acts of employees or agents of the County or Federal Government.
- (f) Restrictions on Access to Patent Rights. Nothing contained in this section on rights in data will imply a license to the County or Federal Government under any patent or be construed as affecting the scope of any license or other right otherwise granted to the County or Federal Government under any patent.
- (g) Application on Materials Incorporated into Project. The requirements of Subsections 2, 3, and 4 of this Section do not apply to material furnished by the County and incorporated into the work.

GENERAL CONDITIONS5. Records and Audits

Contractor will deliver or cause to be delivered all documents (including but not limited to all Deliverables and supporting data, records, graphs, charts and notes) prepared by or for the County under the terms of this Agreement to the County promptly in accordance with the time limits prescribed in this Contract, and if no time limit is specified, then upon reasonable demand therefor or upon termination or completion of the Services hereunder. In the event of the failure by the Contractor to make such delivery, then and in that event, the Contractor will pay to County reasonable damages the County may sustain by reason thereof.

The County and the Federal Government will have the right to audit all payments made to the Contractor under this Agreement. Any payments to the Contractor which exceed the amount to which the Contractor is entitled under the terms of this Agreement will be subject to set-off.

The Contractor will keep and retain records relating to this Agreement and will make such records available to representatives of the County and the Federal Government, including without limitation the sponsoring federal agency, other participating agencies, and the Comptroller General of the United States, at reasonable times during the performance of this Agreement and for at least five years after termination of this Agreement for purposes of audit, inspection, copying, transcribing and abstracting.

No provision in this Agreement granting the County or the Federal Government a right of access to records is intended to impair, limit or affect any right of access to such records which the County or the Federal Government would have had in the absence of such provisions.

GC-38 FEDERAL CLAUSES (con't.)6. Environmental Requirements

The Contractor recognizes that many Federal and state laws imposing environmental and resource conservation requirements may apply to the Contract. Some, but not all, of the major Federal Laws that may affect the Contract include: the National Environmental Policy Act of 1969, as amended, 42 U.S.C. §§ 4321 et seq.; the Clean Air Act, as amended, 42 U.S.C. §§ 7401 et seq. and scattered sections of 29 U.S.C.; the Clean Water Act, as amended, scattered sections of 33 U.S.C. and 12 U.S.C.; the Resource Conservation and Recovery Act, as amended, 42 U.S.C. §§ 6901 et seq.; and the Comprehensive Environmental Response, Compensation, and Liability Act, as amended, 42 U.S.C. §§ 9601 et seq. The Contractor also recognizes that U.S. EPA, U.S. DOT and other agencies of the Federal Government have issued and are expected in the future to issue regulations, guidelines, standards, orders, directives, or other requirements that may affect the Contract. Thus, the Contractor agrees to adhere to, and impose on its subcontractors, any such Federal requirements as the Federal Government may now or in the future promulgate. Listed below are requirements of particular concern.

The Contractor acknowledges that this list does not constitute the Contractor's entire obligation to meet all Federal environmental and resource conservation requirements. The Contractor will include these provisions in all subcontracts.

- (a) Environmental Protection. The Contractor agrees to comply with the applicable requirements of the National Environmental Policy Act of 1969, as amended, 42 U.S.C. §§ 4321 et seq. in accordance with Executive Order No. 12898, "Federal Actions to Address Environmental Justice in Minority Populations and Low-Income Populations," 59 Fed. Reg. 7629, Feb. 16, 1994; U.S. DOT statutory requirements on environmental matters at 49 U.S.C. § 5324(b); Council on Environmental Quality regulations on compliance with the National Environmental Policy Act of 1969, as amended, 40 C.F.R. Part 1500 et seq.; and U.S. DOT regulations, "Environmental Impact and Related Procedures," 23 C.F.R. Part 771 and 49 C.F.R. Part 622.
- (b) Air Quality. The Contractor agrees to comply with all applicable standards, orders, or regulations issued pursuant to the Clean Air Act, as amended, 42 U.S.C. §§ 7401 et seq. Specifically, the Contractor agrees to comply with applicable requirements of U.S. EPA regulations, "Conformity to

GENERAL CONDITIONS

State of Federal Implementation Plans of Transportation Plans, Programs, and Projects Developed, Funded or Approved Under Title 23 U.S.C. or the Federal Transit Act," 40 C.F.R. Part 51, Subpart T; and "Determining Conformity of Federal Actions to State or Federal Implementation Plans," 40 C.F.R. Part 93. The Contractor further agrees to report and require each subcontractor at any tier to report any violation of these requirements resulting from any Contract implementation activity to the County and the appropriate U.S. EPA Regional Office.

- (c) Clean Water. The Contractor agrees to comply with all applicable standards, orders, or regulations issued pursuant to the Federal Water Pollution Control Act, as amended, 33 U.S.C. §§ 1251 et seq. The Contractor further agrees to report and require each subcontractor at any tier to report any violation of these requirements resulting from any Contract implementation activity to the County and the appropriate U.S. EPA Regional Office.
- (d) List of Violating Facilities. The Contractor agrees that any facility to be used in the performance of the Contract or to benefit from the Contract will not be listed on the U.S. EPA List of Violating Facilities ("List"), and the Contractor will promptly notify the County if the Contractor receives any communication from the U.S. EPA that such a facility is under consideration for inclusion on the List.

GC-38 FEDERAL CLAUSES (con't.)

- (e) Preference for Recycled Products. To the extent practicable and economically feasible and to the extent that it does not reduce or impair the quality of the work, the Contractor agrees to use recycled products in performance of the Contract pursuant to U.S. Environment Protection Agency (U.S. EPA) guidelines at 40 C.F.R. Parts 247-253, which implement section 6002 of the Resource Conservation and Recovery Act, as amended, 42 U.S.C. § 6962.

7. No Exclusionary or Discriminatory Specifications

Apart from inconsistent requirements imposed by Federal statute or regulations, the Contractor agrees that it will comply with the requirements of 49 U.S.C. § 5323(h)(2) by refraining from using any Federal assistance to support subcontracts procured using exclusionary or discriminatory specifications.

8. Cargo Preference - Use of United States Flag Vessels

The Contractor agrees to comply with U.S. Maritime Administration regulations, "Cargo-Preference -- U.S. Flag Vessels," 49 C.F.R. Part 381, and to include the clauses required by those regulations, modified as necessary to identify the affected parties, in each subcontract or subagreement involving equipment, materials, or commodities suitable for transport by ocean vessel.

9. Fly America

Section 14.c of the Master Agreement states that if the contract or subcontracts may involve the international transportation of goods, equipment, or personnel by air, the contract must require Contractors and subcontractors at every tier to use U.S.-flag air carriers, to the extent service by these carriers is available. 49 U.S.C. 40118 and 4 C.F.R. Part 52.

10. No Federal Government Obligations to Third Parties

The Contractor agrees that, absent the Federal Government's express written consent, the Federal Government will not be subject to any obligations or liabilities to any contractor or any other person not a party to the Grant Agreement or Cooperative Agreement between the County and the Federal Government which is a source of funds for this Contract. Notwithstanding any concurrence provided by the Federal Government in or approval of any solicitation, agreement, or contract, the Federal Government continues to have no obligations or liabilities to any party, including the Contractor.

GENERAL CONDITIONS11. Allowable Costs

Notwithstanding any compensation provision to the contrary, the Contractor's compensation under this Contract will be limited to those amounts which are allowable and allocable to the Contract in accordance

with OMB Circular A-87 and the regulations in 49 C.F.R. Part 18. To the extent that an audit reveals that the Contractor has received payment in excess of such amounts, the County may offset such excess payments against any future payments due to the Contractor and, if no future payments are due or if future payments are less than such excess, the Contractor will promptly refund the amount of the excess payments to the County.

12. Trade Restrictions

Contractor certifies that neither it nor any Subcontractor:

GC-38 FEDERAL CLAUSES (con't.)

- (a) is owned or controlled by one or more citizens of a foreign country included in the list of countries that discriminate against U.S. firms published by the Office of the United States Trade Representative (USTR);
- (b) has knowingly entered into any contract or subcontract with a person that is a citizen or national of a foreign country on said list, nor is owned or controlled directly or indirectly by one or more citizens or nationals of a foreign country on said list;
- (c) will procure, subcontract for, or recommend any product that is produced in a foreign country on said list.

Unless the restrictions of this clause are waived by the Secretary of Transportation in accordance with 49 CFR 30.17, no Notice-to-Proceed will be issued to an entity who is unable to certify to the above. If Contractor knowingly procures or subcontracts for the supply of any product or service of a foreign country on said list for use on the project, the USDOT may direct, through the County, cancellation of the Contract at no cost to the Government.

Further, Contractor agrees that it will incorporate this provision for certification without modification in each subcontract. Contractor may rely on the certification of a prospective Subcontractor unless it has knowledge that the certification is erroneous. Contractor will provide immediate written notice to the County if it learns that its certification or that of a Subcontractor was erroneous when submitted or has become erroneous by reason of changed circumstances. Each Subcontractor must agree to provide written notice to Contractor if at any time it learns that its certification was erroneous by reason of changed circumstances. Nothing contained in the foregoing will be construed to require establishment of a system of records in order to render, in good faith, the certification required by this provision.

The knowledge and information of the Contractor is not required to exceed that which is normally possessed by a prudent person in the ordinary course of business dealings.

This certification concerns a matter within the jurisdiction of an agency of the United States of America and the making of a false, fictitious, or fraudulent certification may render the maker subject to prosecution under Title 18, United States Code, Section 100.

13. Contract Work Hours and Safety Standards Act

If applicable according to their terms, the Contractor agrees to comply and assures compliance with sections 102 and 107 of the Contract Work Hours and Safety Standards Act, as amended, 40 U.S.C. §§ 327 through 333, and implementing U.S. DOL regulations, "Labor Standards Provisions Applicable to Contracts Governing Federally Financed and Assisted Construction (also Labor Standards Provisions Applicable to Nonconstruction Contracts Subject to the Contract Work Hours and Safety Standards Act)," 29 C.F.R. Part 5; and U.S. DOL regulations, "Safety and Health Regulations for Construction," 29 C.F.R. Part 1926. In addition to other requirements that may apply:

GENERAL CONDITIONS

- (a) In accordance with section of the Contract Work Hours and Safety Standards Act, as amended, 40 U.S.C. §§ 327 through 332, the Contractor agrees and assures that, for the Contract, the wages of every mechanic and laborer will be computed on the basis of a standard work week of 40 hours, and that each worker will be compensated for work exceeding the standard work week at a rate of not less than 1.5 times the basic rate of pay for all hours worked in excess of 40 hours in the work week. The Contractor agrees that determinations pertaining to these requirements will be made in accordance with applicable U.S. DOL regulations, "Labor Standards Provisions Applicable to Contracts Governing Federally Financed and Assisted Construction (also Labor Standards Provisions Applicable to Nonconstruction Contracts Subject to the Contract Work Hours and Safety Standards Act)," 29 C.F.R. Part 5.

GC-38 FEDERAL CLAUSES (con't.)

- (b) In accordance with section 107 of the Contract Work Hours and Safety Standards Act, as amended, 40 U.S.C. § 333, the contractor agrees and assures that no laborer or mechanic working on a construction contract will be required to work in surroundings or under working conditions that are unsanitary, hazardous, or dangerous to his or her health and safety, as determined in accordance with U.S. DOL regulations, "Safety and Health Regulations for Construction," 29 C.F.R. Part 1926.

14. Veteran's Preference

In the employment of labor (except in executive, administrative, and supervisory positions), preference will be given to Vietnam-era veterans and disabled veterans. However, this preference may be given only where individuals are available and qualified to perform the work to which employment relates.

15. Copyright Ownership

Consultant and the County intend that, to the extent permitted by law, the Deliverables to be produced by Consultant at the County's instance and expense pursuant to this Agreement are conclusively deemed "works made for hire" within the meaning and purview of Section 101 of the United States Copyright Act, 17 U.S.C. §101 et seq. (the "Copyright Act"), and that the County will be the copyright owner of the Deliverables and of all aspects, elements and components of them in which copyright can subsist.

To the extent that any Deliverable does not qualify as a "work made for hire," Consultant irrevocably grants, conveys, bargains, sells, assigns, transfers and delivers to the County, its successors and assigns, all right, title and interest in and to the copyrights and all U.S. and foreign copyright registrations, copyright applications and copyright renewals for them, and other intangible, intellectual property embodied in or pertaining to the Deliverables prepared for the County under this Agreement, free and clear of any liens, claims or other encumbrances, to the fullest extent permitted by law. Consultant will execute all documents and perform all acts that the County may reasonably request in order to assist the County in perfecting its rights in and to the copyrights relating to the Deliverables, at the sole expense of the County.

Consultant warrants to County, its successors and assigns, that on the date of transfer Consultant is the lawful owner of good and marketable title in and to the copyrights for the Deliverables and has the legal rights to fully assign them. Consultant further warrants that it has not assigned any copyrights nor granted any licenses, exclusive or nonexclusive, to any other party, and that it is not a party to any other agreements or subject to any other restrictions with respect to the Deliverables. Consultant warrants and represents that the Deliverables are complete and comprehensive, and the Deliverables are a work of original authorship.

16. Accessibility Compliance

If this Agreement involves design for construction, the Consultant warrants that all design documents produced or utilized under this Agreement and all construction or alterations undertaken under this Agreement will comply with all federal, state and local laws and regulations regarding accessibility standards for persons with disabilities or environmentally limited persons including, but not limited to, the following: the Americans with Disabilities Act of 1990, 42 U.S.C. § 12101 et seq. and the Americans with Disabilities Act Accessibility Guidelines for Buildings and Facilities ("ADAAG"); the Architectural Barriers Act, Pub. L. 90-480 (1968), and the Uniform Federal Accessibility Standards ("UFAS"); and the Illinois Environmental Barriers Act, 410 ILCS

GENERAL CONDITIONS

25/1 et seq., and all regulations promulgated thereunder, see Illinois Administrative Code, Title 71, Chapter 1, Section 400.110. If the above standards are inconsistent, the Consultant must comply with the standard providing the greatest accessibility. Also, the Consultant must, prior to construction,

review the plans and specifications to insure compliance with the above referenced standards. If the Consultant fails to comply with the foregoing standards, the Consultant must perform again, at no expense, all services required to be re-performed as a direct or indirect result of such failure.

GC-38 FEDERAL CLAUSES (con't.)

17. Visual Rights Act Waiver

The Consultant/Contractor waives any and all rights that may be granted or conferred under Section 106A and Section 113 of the United States Copyright Act, (17 U.S.C. § 101 et seq.) (the "Copyright Act") in any work of visual art that may be provided pursuant to this Agreement. Also, the Consultant/Contractor represents and warrants that the Consultant/Contractor has obtained a waiver of Section 106A and Section 113 of the Copyright Act as necessary from any employees and subcontractors, if any.

18. Equal Employment Opportunity

During the performance of this contract, the contractor agrees as follows:

(1) The contractor will not discriminate against any employee or applicant for employment because of race, color, religion, sex, sexual orientation, gender identity, or national origin. The contractor will take affirmative action to ensure that applicants are employed, and that employees are treated during employment without regard to their race, color, religion, sex, sexual orientation, gender identity, or national origin. Such action shall include, but not be limited to the following:

Employment, upgrading, demotion, or transfer; recruitment or recruitment advertising; layoff or termination; rates of pay or other forms of compensation; and selection for training, including apprenticeship. The contractor agrees to post in conspicuous places, available to employees and applicants for employment, notices to be provided setting forth the provisions of this nondiscrimination clause.

(2) The contractor will, in all solicitations or advertisements for employees placed by or on behalf of the contractor, state that all qualified applicants will receive consideration for employment without regard to race, color, religion, sex, sexual orientation, gender identity, or national origin.

(3) The contractor will not discharge or in any other manner discriminate against any employee or applicant for employment because such employee or applicant has inquired about, discussed, or disclosed the compensation of the employee or applicant or another employee or applicant. This provision shall not apply to instances in which an employee who has access to the compensation information of other employees or applicants as a part of such employee's essential job functions discloses the compensation of such other employees or applicants to individuals who do not otherwise have access to such information, unless such disclosure is in response to a formal complaint or charge, in furtherance of an investigation, proceeding, hearing, or action, including an investigation conducted by the employer, or is consistent with the contractor's legal duty to furnish information.

(4) The contractor will send to each labor union or representative of workers with which he has a collective bargaining agreement or other contract or understanding, a notice to be provided advising the said labor union or workers' representatives of the contractor's commitments under this section, and shall post copies of the notice in conspicuous places available to employees and applicants for employment.

(5) The contractor will comply with all provisions of Executive Order 11246 of September 24, 1965, and of the rules, regulations, and relevant orders of the Secretary of Labor.

(6) The contractor will furnish all information and reports required by Executive Order 11246 of September 24, 1965, and by rules, regulations, and orders of the Secretary of Labor, or pursuant thereto, and will permit

GENERAL CONDITIONS

access to his books, records, and accounts by the administering agency and the Secretary of Labor for purposes of investigation to ascertain compliance with such rules, regulations, and orders.

(7) In the event of the contractor's noncompliance with the nondiscrimination clauses of this contract or with any of the said rules, regulations, or orders, this contract may be canceled, terminated, or suspended in whole or in part and the contractor may be declared ineligible for further Government contracts or federally assisted construction contracts in accordance with procedures authorized in Executive Order 11246 of September 24,

GC-38 FEDERAL CLAUSES (con't.)

1965, and such other sanctions may be imposed and remedies invoked as provided in Executive Order 11246 of September 24, 1965, or by rule, regulation, or order of the Secretary of Labor, or as otherwise provided by law.

(8) The contractor will include the portion of the sentence immediately preceding paragraph (1) and the provisions of paragraphs (1) through (8) in every subcontract or purchase order unless exempted by rules, regulations, or orders of the Secretary of Labor issued pursuant to section 204 of Executive Order 11246 of September 24, 1965, so that such provisions will be binding upon each subcontractor or vendor. The contractor will take such action with respect to any subcontract or purchase order as the administering agency may direct as a means of enforcing such provisions, including sanctions for noncompliance:

Provided, however, that in the event a contractor becomes involved in, or is threatened with, litigation with a subcontractor or vendor as a result of such direction by the administering agency, the contractor may request the United States to enter into such litigation to protect the interests of the United States.

The applicant further agrees that it will be bound by the above equal opportunity clause with respect to its own employment practices when it participates in federally assisted construction work: Provided, That if the applicant so participating is a State or local government, the above equal opportunity clause is not applicable to any agency, instrumentality or subdivision of such government which does not participate in work on or under the contract.

The applicant agrees that it will assist and cooperate actively with the administering agency and the Secretary of Labor in obtaining the compliance of contractors and subcontractors with the equal opportunity clause and the rules, regulations, and relevant orders of the Secretary of Labor, that it will furnish the administering agency and the Secretary of Labor such information as they may require for the supervision of such compliance, and that it will otherwise assist the administering agency in the discharge of the agency's primary responsibility for securing compliance.

The applicant further agrees that it will refrain from entering into any contract or contract modification subject to Executive Order 11246 of September 24, 1965, with a contractor debarred from, or who has not demonstrated eligibility for, Government contracts and federally assisted construction contracts pursuant to the Executive Order and will carry out such sanctions and penalties for violation of the equal opportunity clause as may be imposed upon contractors and subcontractors by the administering agency or the Secretary of Labor pursuant to Part II, Subpart D of the Executive Order. In addition, the applicant agrees that if it fails or refuses to comply with these undertakings, the administering agency may take any or all of the following actions: Cancel, terminate, or suspend in whole or in part this grant (contract, loan, insurance, guarantee); refrain from extending any further assistance to the applicant under the program with respect to which the failure or refund occurred until satisfactory assurance of future compliance has been received from such applicant; and refer the case to the Department of Justice for appropriate legal proceedings.

19. Copeland "Anti-Kickback" Act (40 U.S.C. 3145))

All contracts and subgrants in excess of \$2000 for construction or repair awarded by recipients and subrecipients shall include a provision for compliance with the Copeland "Anti-Kickback" Act (40 U.S.C. 3145), as supplemented by Department of Labor regulations (29 CFR part 3, "Contractors and Subcontractors on Public Building or Public Work Financed in Whole or in Part by Loans or Grants from the United States"). The

GENERAL CONDITIONS

Act provides that each contractor or subrecipient shall be prohibited from inducing, by any means, any person employed in the construction, completion, or repair of public work, to give up any part of the compensation to which he is otherwise entitled. The recipient shall report all suspected or reported violations to the Federal awarding agency.

20. Davis-Bacon Act, as amended ((40 U.S.C. 3141-3148)

GC-38 FEDERAL CLAUSES (con't.)

When required by Federal program legislation, all construction contracts awarded by the recipients and subrecipients of more than \$2000 shall include a provision for compliance with the Davis-Bacon Act ((40 U.S.C. 3141-3148) and as supplemented by Department of Labor regulations (29 CFR part 5, "Labor Standards Provisions Applicable to Contracts Governing Federally Financed and Assisted Construction").

Under this Act, contractors shall be required to pay wages to laborers and mechanics at a rate not less than the minimum wages specified in a wage determination made by the Secretary of Labor. In addition, contractors shall be required to pay wages not less than once a week. The recipient shall place a copy of the current prevailing wage determination issued by the Department of Labor in each solicitation and the award of a contract shall be conditioned upon the acceptance of the wage determination. The recipient shall report all suspected or reported violations to the Federal awarding agency.

21. Contract Work Hours and Safety Standards Act (40 U.S.C. 3701-3708)

Where applicable, all contracts awarded by recipients in excess of \$100,000 that involve the employment of mechanics or laborers shall include a provision for compliance with 40 U.S.C. 3702 and 3704, as supplemented by Department of Labor regulations (29 CFR part 5). Under 40 U.S.C. 3702 of the Act, each contractor shall be required to compute the wages of every mechanic and laborer on the basis of a standard work week of 40 hours. Work in excess of the standard work week is permissible provided that the worker is compensated at a rate of not less than 1 ½ times the basic rate of pay for all hours worked in excess of 40 hours in the work week. The requirements of 40 U.S.C. 3704 are applicable to construction work and provides that no laborer or mechanic shall be required to work in surroundings or under working conditions which are unsanitary, hazardous or dangerous. These requirements do not apply to the purchases of supplies or materials or articles ordinarily available on the open market, or contracts for transportation or transmission of intelligence.

22. Rights to Inventions Made Under a Contract or Agreement

Contracts or agreements for the performance of experimental, developmental, or research work shall provide for the rights of the Federal Government and the recipient in any resulting invention in accordance with 37 CFR part 401, "Rights to Inventions Made by Nonprofit Organizations and Small Business Firms Under Government Grants, Contracts and Cooperative Agreements," and any implementing regulations issued by the awarding agency.

23. Clean Air Act (42 U.S.C. 7401 et seq.) and the Federal Water Pollution Control Act (33 U.S.C. 1251 et seq.), as amended

Contracts and subgrants of amounts in excess of \$150,000 shall contain a provision that requires the recipient to agree to comply with all applicable standards, orders or regulations issued pursuant to the Clean Air Act (42 U.S.C. 7401 et seq.) and the Federal Water Pollution Control Act as amended (33 U.S.C. 1251 et seq.). Violations shall be reported to the Federal awarding agency and the Regional Office of the Environmental Protection Agency (EPA).

24. Byrd Anti-Lobbying Amendment (31 U.S.C. 1352)

Contractors who apply or bid for an award of \$100,000 or more shall file the required certification. Each tier certifies to the tier above that it will not and has not used Federal appropriated funds to pay any person or

GENERAL CONDITIONS

organization for influencing or attempting to influence an officer or employee of any agency, a member of Congress, officer or employee of Congress, or an employee of a member of Congress in connection with obtaining any Federal contract, grant or any other award covered by 31 U.S.C. 1352. Each tier shall also disclose any lobbying with non-Federal funds that takes place in connection with obtaining any Federal award. Such disclosures are forwarded from tier to tier up to the recipient.

25. Debarment and Suspension (E.O.s 12549 and 12689)

No contract shall be made to parties listed on the General Services Administration's List of Parties Excluded from Federal Procurement or Nonprocurement Programs in accordance with E.O.s 12549 and 12689, "Debarment and Suspension." This list contains the names of parties debarred, suspended, or otherwise excluded by agencies, and contractors declared ineligible under statutory or regulatory authority other than E.O. 12549. Contractors with awards that exceed the small purchase threshold shall provide the required certification regarding its exclusion status and that of its principal employees.

26. Prohibition on Certain Telecommunications and Surveillance Equipment

Recipients and subrecipients are prohibited from using loan or grant funds to procure or obtain; extend or renew a contract to procure or obtain; or enter into a contract (or extend or renew a contract) to procure or obtain equipment, services, or systems that uses covered telecommunications equipment or services as a substantial or essential component of any system, or as critical technology as part of any system. As described in [Public Law 115-232, section 889](#), covered telecommunications equipment is telecommunications equipment produced by Huawei Technologies Company or ZTE Corporation (or any subsidiary or affiliate of such entities), Hytera Communications Corporation, Hangzhou Hikvision Digital Technology Company, or Dahua Technology Company (or any subsidiary or affiliate of such entities), or by an entity that the Secretary of Defense, in consultation with the Director of the National Intelligence or the Director of the Federal Bureau of Investigation, reasonably believes to be an entity owned or controlled by, or otherwise connected to, the government of a covered foreign country.

GC-39 CONTRACT INTERPRETATION

Whenever the singular is used herein, the masculine, feminine and neuter gender shall be deemed to include the others. The headings of articles, paragraphs and sections in this Contract are included for convenience only and shall not be considered by either party in construing the meaning of this Contract. If any provision or clause of this Contract shall be held to be invalid, such provision or clause shall be deleted from the Contract and the Contract shall be construed to give effect to the remaining portions thereof.

This Contract shall be interpreted and construed based upon the following order of precedence of component parts. Such order of precedence shall govern to resolve all cases of conflict, ambiguity or inconsistency.

1. Addenda, if any.
2. Special Conditions
3. Specification.
4. General Conditions.
5. Instruction to Bidders.
6. Legal Advertisement.
7. Bid Proposal.

END OF SECTION

SPECIAL CONDITIONS

SC-01 SCOPE

The Bidder shall furnish new 2026 or current model year, New Holland Workmaster 75, or equal Tractor Mower, with new 2026 or current model year, Alamo Switchblade, or equal sickle bar, and new 2026 or current model year, Land Pride RCF 2772 or equal Rotary Mower Boxes. Alamo or equal sickle bar shall be installed on the tractor, turn key ready for use.

Bidder shall also furnish 2026 or current model year Land Pride RCF 3096 or equal Rotary Mower boxes for the Cook County Department of Transportation and Highway, all in accordance with the Contract Documents, Specifications and Proposal herein.

SC-02 CONTRACT PERIOD

The contract is effective February 14, 2026 through February 13, 2028, with one (1), one, year-renewal option effective after award by the CPO or Board of Commissioners and after proper execution of the Contract Documents.

SC-03 AWARD OF CONTRACT

The Contract shall be awarded to the lowest, responsible, and responsive Bidder whose bid meets the requirements and criteria set forth in the Bid Documents. All items, unless otherwise stated, will be assumed to meet all specifications and requirements as set forth in the Bid Documents. Ambiguous bids which are uncertain as to terms, delivery, quantity, or compliance with specifications may be declared non-responsive and rejected. The County shall be sole determinant of the relevant and appropriate cost factors used in evaluating any Base, Options and/or Alternate bids. Bidders must quote all lines for consideration. It is the intent of the County to award this bid in whole and not in part. Only one award will result from this bid.

The awarded contractor shall furnish all equipment, materials, delivery, training, and related services necessary to meet the specifications outlined in this document.

SC-04 MBE/WBE REQUIREMENTS FOR THIS CONTRACT

The Bidder shall have a subcontracting goal of not less than 0% MBE and 0% WBE of the awarded contract price for work to be performed.

The Bidder must comply with the County's MBE/WBE participation requirements. The County has issued MBE/WBE goals for this Bid. The Bidder shall submit with its Proposal, an MBE/WBE Utilization Plan indicating how it proposes to meet these goals. If the Bidder has not met the goals or made good faith efforts to meet the goals, the Bidder's response will be deemed nonresponsive and will not be considered for award.

Certified MBE/WBE Bidders may count their own participation, however, a woman owned firm certified as M/WBE or W/MBE may be counted towards the MBE or WBE goal, but not both. (Designations cannot be changed after submission of the compliance plan.)

Unless otherwise specified in the Bid Documents, for purposes of this contract, the contract amount is the total bid amount that has been entered on the Bon Fire Proposal Page of the Bid Documents.

SC-05 DELIVERY REQUIREMENTS

- A. The Vendor must contact Randy Piscitelli, Facilities, and Equipment Manager at (312) 802-5785 48 hours before delivery and report to Mr. Piscitelli upon delivery. Time of deliveries shall be between the hours of 10:00 a.m. and 3:00 p.m., Monday through Friday, except the following holidays: Columbus Day, Veteran's Day, Memorial Day, Juneteenth Day, Independence Day, Labor Day, Thanksgiving Day, Christmas Day, New Year's Day, Martin Luther King, Jr. Day, Casimir Pulaski Day, Lincoln's Birthday and Washington's Birthday.
- B. No Equipment deliveries will be accepted unless the Vendor has fulfilled all of the requirements of this contract.
- C. The Vendor must supply the Cook County Department of Transportation and Highways with the following items for each unit being delivered, where applicable: Certificate of Origin and line sheet, odometer reading statement (in addition to odometer disclosure on certificate of origin), and applicable warranty certificates.
- D. The Vendor must submit signed delivery receipts with their invoices in order for invoices to be processed for payment. The Purchase Order number must appear on the delivery receipt.
- E. Delivery shall be F.O.B. Destination
- F. Vehicle must include a full tank of fuel when delivered.
- G. Delivery shall be made to:

Cook County Department of Transportation and Highways
8900 W. 135th Street
Orland Park, IL 60462
Attn: Randy Piscitelli
312-802-5785

Cook County Department of Transportation and Highways
2101 Ballard Rd.
Des Plaines, IL.60016
Attn: Randy Piscitelli
312-802-5785

SC-06 PRE-DELIVERY, SERVICING AND ADJUSTMENTS

Prior to delivery of any vehicle, the Vendor will perform all preparatory operations recommended by the manufacturer, including (where applicable):

1. Tuning the engine.
2. Testing the operation of all accessories.
3. Testing electrical, hydraulic and air systems.
4. Charging batteries.
5. Inflating tires to recommended pressures.
6. Lubricating all fittings and friction points.
7. Filling all lubricant and fluid reservoirs; and
8. Filling fuel tank using fresh fuel.

SC-07 INSPECTION UPON DELIVERY

- A. Upon delivery of the vehicle, Cook County will conduct an initial visual examination solely for the purpose of identifying gross and obvious damage. The Vendor's representative may be present for the initial examinations. If defects or omissions are discovered during the inspection, Cook County may:
1. Refuse acceptance of any units.
 2. Arrange with the Vendor to make corrections.
 3. Require the Vendor or to remove any units from Cook County's premises at its own cost to make the necessary corrections
- B. The Vendor must provide all labor and materials that may be required to correct non-compliant aspects of all items in a prompt manner, at no cost to Cook County. The "promptness" of corrective actions will be established by Cook County based upon the quantity and scope of the corrections required.

SC-08 LITERATURE AND DRAWINGS

The vendor is requested to submit copies of each of the following information items with the Bid.

- A. Detailed view drawing of the proposed Tractor with Cab, Sickle bar and Rotary Mower boxes listing the dimensions including Base Build, Chassis, Wheelbase, Cab to Axel, Overall, Height.
- B. Manufacturers published literature for all pertinent chassis components, i.e., engine, transmission, and axels.
- C. Manufacturers published literature for the proposed Tractor Mower and Attachments.
- D. Detailed multiple-view drawings of the proposed Tractor Mower, Sickle bar and Rotary Mower Boxes.

SC-09 MANUALS, CERTIFICATES, APPLICATIONS

Manuals must be provided in English, one (1) operators manual, hard copy must be provided with each Tractor Mower. One (1) operator's manual, hard copy for each aftermarket accessory must also be provided with each Tractor Mower purchased.

The Vendor must furnish, in English, six (6) sets of Maintenance Manuals for the proposed Tractor, Sickle Bar and Rotary Mower box.

- Technical Service bulletins (TSB's) must be forwarded directly to the Equipment Division of the Cook County Transportation and Highways Department office as they are issued.
- Manufacturer's Warranty Card (or Interim Temporary Card).
- Manufacturer's Certificate of Origin
- Completed Illinois Department of Revenue Form #ST556 (for Illinois suppliers) or RUT-25 (for out of state suppliers) must be provided a minimum of 48 hours prior to delivery. Forms can be obtained through the Department of revenue by calling (800) 356-6302.
- Note: the above listed documents must indicate Cook County as the owner of the Tractor Mower. The respective department name must also be indicated on all documents in the appropriate places.
- Department of Transportation certification of completed vehicle.
- One (1) test of the complete unit must be performed in accordance with OSHA/ANSI requirements, and the vendor is to provide documentation with the delivery of the Tractor Mowers with Attachments.
Link:
- No Tractor Mower deliveries will be accepted unless the Bidder has fulfilled all of the abovelisted requirements.

SC-10 TRAINING:

- A. The Vendor must furnish Professionally Conducted Training Sessions. This Training will be provided by the Vendor as a portion of the Contract at no additional cost to Cook County.
- B. The Training shall be held in two (2) sessions. One session at each delivery location.
- C. The Vendor will provide training for Cook County Road Maintenance Personnel on the proper safe operation of the Tractor Mower and all auxiliary items for a minimum of 4 hours at the Cook County Department of Transportation Maintenance Facility. In addition, the Vendor shall provide 2 hours of orientation for the Cook County Garage Maintenance personnel. The Maintenance Personnel shall be orientated in diagnostic and preventative maintenance procedures, general maintenance, and repair along with systems reconditioning for the Tractor Mower and all auxiliary items.

SC-11 INQUIRIES

Any written request for interpretation of documents shall be submitted via

Inquiries about the interpretation of the Specifications must be made only in writing and shall be directed to the Chief Procurement Officer. Inquiries will be answered in writing, if deemed necessary, by means of an Addendum issued by the Office of the Chief Procurement Officer. (Reference Instructions to Bidders, Section IB-05 "Exceptions and Addendum", Page IB-3).

Inquiries must be received no later than 1:00 p.m. Local Time - Chicago on October 9, 2025.

During the bid period, all inquiries must be submitted via the link provided above.

SC-12 BIDDER ACKNOWLEDGEMENT

By submitting their bid, the Bidder acknowledges that it has carefully examined all pages and documents contained within this solicitation, and that they have familiarized themselves with all terms and conditions therein. Further, the Bidder understands that by submitting their bid they waive all rights to plead any misunderstanding regarding said terms and conditions.

The Bidder also acknowledges all fees and charges necessary to provide the goods and/or services, including but not limited to shipping and delivery must be included in the Unit Price. Items will be ordered in various quantities on an "As Needed" basis.

Bidder further acknowledges they are to provide specific line-item pricing and extended pricing for this solicitation in the bid table located in Bonfire.

SC-13 BID PRICES MUST INCORPORATE ALL COSTS

Bid/Unit Prices must incorporate any and all costs, including but not limited to the costs of the goods/services, delivery/transportation charges, training, equipment, materials, labor, insurance, applicable taxes, warranty, overhead and profit, etc. that are required to provide the goods and/or services discussed in this solicitation.

SC-14 PRICE ADJUSTMENT

Quoted prices will remain fixed throughout the first twelve (12) calendar months of the Contract term. Beginning on the date after the initial twelve (12) month term, and for each twelve (12) month anniversary thereafter, subject to acceptable performance by the Contractor and contingent upon the appropriation of sufficient funds for the procurement of services provided for in this Contract, annual price adjustments of the Contract pricing may be made after receipt of written request from the Contractor showing cause substantiating the need for the increase, made no later than thirty (30) calendar days after the expiration of each such twelve (12) month period. If Contractor does not request a price adjustment within such thirty (30) calendar day period, Contractor will not be entitled to a price adjustment for the upcoming year. Contract pricing adjustments will be calculated as outlined below.

SC-15 NOTIFICATION

Do not begin performance on the Contract until notified by the Using Agency

REMAINDER OF THIS PAGE IS INTENTIONALL LEFT BLANK

SPECIFICATIONS**ITEM NO. 1 2025 OR CURRENT MODEL YEAR NEW HOLLAND WORKMASTER 75 UTILITY TRACTOR MOWER OR EQUAL WITH SICKLE BAR AND ROTARY MOWER BOX.**

It is the intent of these specifications to describe a new Four (4) wheel Drive Utility Tractor with factory installed climate controlled high visibility canopy. The suitable Tractor shall come equipped with an Alamo Industrial, Switchblade or equal Sickle Bar Mower attachment. The Sickle Bar Mower Attachment shall be mid-mounted to the Tractor, right side, curb side, and ready for use, turn key. The suitable Tractor shall be capable of powering and Lifting a Land Pride RCF 2772 or equal Rotary Mower box. All functions of the Mowing attachments shall be Joy Stick controlled inside the Cab of the Tractor.

Operator Station

1. Premium Enclosed Cab
 - a. Heat and Air conditioning.
 - b. AM/FM Radio with Bluetooth.
 - c. High Visibility Window Panels
 - d. Windshield Wipers, front and rear
2. Driver's Seat
 - a. Air Ride suspension.
 - b. Seat Belt.
3. Engine
 - a. Three (3) Cylinder, Turbo, minimum two-point two-liter (2.2L) displacement.
 - b. Gross Engine Horsepower: minimum (70 HP) Seventy Horsepower.
 - c. P.T.O Horsepower: minimum (60 HP) Sixty Horsepower.
 - d. Rear Power Take off: (540 Five Hundred Forty Standard.
 - e. Air Filter Type: Dry, Dual Element, Two (2) Stage.
4. Fuel System
 - a. Fuel System: High pressure common rail, direct injection,
 - b. Fuel Filter Type: Dual Stage fuel filtering system with water sediment separator followed by a paper filter element cartridge.
 - c. Fuel Tank Capacity: minimum Twenty (20) Gallons.
5. Transmission
 - a. Eight (8) X Eight (8) Reverse.
 - b. Clutch Type, Dry.
 - c. Four (4) Wheel Drive
 - d. Rear Power Take Off (PTO) engagement: Mechanical with hydraulic assist.
6. Exhaust
 - a. Exhaust: A pillar with guard on right side of tractor
 - b. Tier 4 Emissions
7. Electrical
 - a. Battery: 12 Volts, minimum (800 CCA) eight hundred cold cranking Amps.
 - b. Alternator: Minimum one hundred (100) amps.
 - c. Battery disconnect switch.
8. Tires
 - a. Front: 11.2-24" (inch) 6PR R1 Bias Ply
 - b. Rear: 16.9-30" (inch) 6PR R1 Bias Ply
9. Hydraulic System
 - a. System Type: Open Center, Fixed Displacement Pump.
 - b. Steering, Pump capacity, Minimum five point five (5.5 GPM) gallons per minute
 - c. Service Pump capacity, minimum twelve (12 GPM) gallons per minute.
 - d. Double Stackable Rear Control Valves with lever Control

SPECIFICATIONS

10. 3 Point Hitch
- Lift capacity 24" (inches) behind pin: Minimum three thousand two hundred pounds (3,200 Lbs.)
 - Category 2 Hitch, Mechanical Top link sensing.
 - Lift Arms: Flexible
 - Stabilizers: Telescopic
11. Dimensions
- Overall length: minimum (130") One hundred thirty inches.
 - Overall height: minimum (95") ninety-five Inches
 - Weight: minimum (6000 lbs.) Six thousand pounds.
12. Options
- 12-volt power outlet mounted inside Cab.
 - Cab mounted work lights.
 - Amber Warning Light L.E.D Light Emitting Diode post mounted on left side of Cab.

Item No. 2 ALAMO SWITCHBLADE SICKLE BAR MOWER OR EQUAL

The Alamo Industrial Switchblade or equal Sickle Bar shall be Hydraulically powered. The Sickle Bar Mower shall be capable of cutting Grass and Weeds up to one half inch thick in diameter. The Hydraulic power for the Sickle Bar shall be supplied by a front mounted pump, driven from the Tractor's engine crank shaft.

- Knife and Cutter Bar:**
 - The Cutter Bar shall be six (6) foot long single wing.
 - Three Inch (3") wide heavy duty Industrial Roak guards in series.
 - Adjustment of the lead angle shall be easily accomplished.
 - The tilt adjustment of the Sickle Bar shall be positive ten (10) degree to negative ten (10) degrees from a Zero (0) degree center line, to provide twenty (20) degrees of total movement
 - The Cutter bar shall be fully floating, terrain following.
- Shoe Soles:**
 - The Shoe Soles shall be constructed of three sixteenths inch (3/16") abrasion resistant steel, three sixty (360) minimum Brinell.
 - The Shoe Soles shall be easily replaceable.
- Hydraulic Motor:**
 - The Hydraulic Motor shall be mounted directly on the cutter bar and directly coupled to the cutter drive unit.
 - The drive unit shall be a gear-driven planetary-type excluding a pitman arm.
 - The Hydraulic Motor shall be operated by a control near the operator and shall be reversable, in any cutter bar position, to clear knife if plugged.
 - The Motor control shall be electric over hydraulic type with a switch that prevents the Tractor from starting with the motor engaged.
 - There shall be no belt drive on the unit.
- Hydraulic Controls:**
 - The cutter bar position controls shall be hydraulically operated and located near the operator.
 - The controls shall be capable of operating two (2) cylinders which position the cutter bar at angles ranging from ninety (90) degrees above horizontal to seventy-five (75) degrees below horizontal, and from two inches (2") below grade to twelve inches (12") above grade while in the horizontal cutting position.
 - The hydraulic circuit shall be capable of supplying full-system flow to the cutter bar motor, while the position controls are being operated.
 - The hydraulic control valve shall incorporate check valves to lock and hold the cutter bar position.
- Knife Obstruction Relief:**

SPECIFICATIONS

- a. The Cutter bar shall have a suitable relief valve in the hydraulic circuit to protect the knife and other mower components from damage if a knife jams.
6. Cutter Bar Safety Breakaway:
- a. The cutter bar shall be equipped with an automatic, self-returning, breakaway system so it will break back from obstructions and return to the normal operating position without the need of operator attention.
 - b. The break away system shall include an elastomeric shock absorber for soft return position.
 - c. The break away swing shall be ninety (90) degree maximum.
7. Mounting:
- a. The Mower shall be side mounted to the Tractor, ahead of the right rear wheel.
8. Safety Up-Lock:
- b. The unit shall be equipped with a mechanical safety transport lock, which removes the load from the hydraulic cylinders.

ITEM NO: 3 Land Pride RCF 2772 OR EQUAL ROTARY CUTTER MOWER BOX

- a. Cutting width: minimum (72") Seventy-two inches
- b. Transport width: minimum (75") Seventy-five Inches.
- c. Overall length: minimum (106") One Hundred Six Inches.
- d. Cutting Height Range: (1.5" to 12") one point five to twelve inches.
- e. Approximate weight: (1050) one thousand fifty pounds.
- f. Tractor Horse Power, minimum 30 to 130 (thirty to one thirty)
- g. Tractor Power Take Off (PTO) speed: 540 RPM (revolutions per minute)
- h. 3 Point Hitch: Lift Type Category 1 Clevis
- i. Driveline: Category 4 (four)
- j. Driveline protection: 4 (four) Plate Slip Clutch
- k. Gear box HP (horsepower): minimum 125 (one hundred twenty-five).
- l. Blade dimensions: Thickness 0.5" (half Inch) X 4.0" (four inch) width X .25" (quarter inch) thickness
- m. Number of Blades: 2 (Two)
- n. Blade Tip Speed: minimum (14,000 FPM) fourteen thousand Flaes Per Minute.
- o. Cutter Deck Thickness: minimum 10 (ten) Gauge
- p. Deck Side Skirt Material thickness: minimum .025" (quarter inch)
- q. Tail Wheel: 4"X8"X15" inch Puncture Proof laminated tire with cast iron hub tire and tapered roller bearings.
- r. Safety: Front and Rear Chain Guards.

SPECIFICATIONS

ITEM NO: 4 LAND PRIDE RCF3096 OR EQUAL ROTARY MOWER CUTTER BOX

- s. Cutting width: minimum (96") Ninety-Six inches
- t. Transport width: minimum (100") One Hundred Inches.
- u. Overall length: minimum (102") One Hundred Two Inches.
- v. Cutting Height Range: (2" to 12") Two to Twelve inches
- w. Approximate weight: (1587 lbs.) One Thousand Five Hundred Eighty-Seven Pounds
- x. Tractor HP (Horsepower): Minimum (50-110HP) Fifty to One Hundred Ten Horsepower
- y. Tractor Power Take Off (PTO) speed: 540 RPM (revolutions per minute)
- z. 3 Point Hitch: Lift Type Category 1 Clevis
- aa. Driveline: Category 4 (four)
- bb. Driveline protection: Main Slip Clutch Drive
- cc. Gear box HP (horsepower): minimum (160) One Hundred Sixty.
- dd. Blade dimensions: Thickness 0.5" (half Inch) X 4.0" (four inch) width
- ee. Number of Blades: (4) Four
- ff. Blade Tip Speed: minimum (16000 FPM) Sixteen thousand Flales Per Minute.
- gg. Cutter Deck Thickness: minimum (10) ten Gauge
- hh. Deck Side Skirt Thickness: Minimum (1/4") One Quarter.
- ii. Tail Wheel: (2) Two 4X8X15 1/4" Four by Eight by Fifteen and inch Puncture Proof laminated.
- jj. Safety: Front and Rear single Chain Guards.

SITE INSPECTION CERTIFICATE

(NOT APPLICABLE)

This is to verify that Bidder has, this date, participated in the Mandatory Site Inspection as required in this Bid. Bidder has inspected the site and related Bid Documents and fully familiarized itself with all conditions and matters which might in any way affect the Deliverables, including costs and scheduling.

NAME (PRINTED/TYPED AND SIGNATURE)

COMPANY

OFFICIAL CAPACITY

TELEPHONE NUMBER (Area Code)

NOTE: This form must be filled in completely and returned with Bid Proposal.

INSPECTION CONFIRMED BY: _____

DATE: _____

EXHIBIT I

Instructions for Submitting an Electronic Bid

SPECIFICATIONS

Refer to **Bid Table in Bonfire for Specifications for Tractor Mowers with Attachments** price page.

Note:

The pricing must be entered in the Bid table in Bonfire. Refer to the Opportunity section which provides an overview of the solicitation process. To view and download the documents PDF files and Bid Table, scroll down to the bottom of the page and select "Prepare Your Submission". See screenshot below.

Submission

Continue

Prepare Your Submission

Prepare Your Submission

Prepare Your Submission

...

INSTRUCTIONS FOR SUBMITTING AN ELECTRONIC BID/PROPOSAL/QUALIFICATION

For electronic submissions, firms shall use the following link to submit Bids/Proposals/Qualifications electronically:

Follow the steps listed in the below article to access the opportunity and submit your bid/proposal.

There is also a video on Vendor Registration & Submission at this link:

If you have questions or technical issues accessing or submitting your bid/proposal, please reach out to Bonfire at:

Extension #2

Exhibit II

Identification of Subcontractors/Supplier/Subconsultant Form

**Cook County
Office of the Chief Procurement Officer
Identification of Subcontractor/Supplier/Subconsultant Form**

OCPO ONLY:	
<input type="checkbox"/>	Disqualification
<input checked="" type="checkbox"/>	Check Complete

The Bidder/Proposer/Respondent ("the Contractor") will fully complete and execute and submit an Identification of Subcontractor/Supplier/Subconsultant Form ("ISF") with each Bid, Request for Proposal, and Request for Qualification. The Contractor must complete the ISF for each Subcontractor, Supplier or Subconsultant which shall be used on the Contract. In the event that there are any changes in the utilization of Subcontractors, Suppliers or Subconsultants, the Contractor must file an updated ISF.

Bid/RFP/RFQ No.: 2457 100IR	Date: 12/17/2025
Total Bid or Proposal Amount: \$ 1,206,696.00	Contract Title: Tractor Mowers and Attachments
Contractor: McCullough Equipment Inc., dba McCullough Kubota	Subcontractor/Supplier/ Subconsultant to be added or substitute: NA
Authorized Contact for Contractor: David Wawrzyniec	Authorized Contact for Subcontractor/Supplier/ Subconsultant: NA
Email Address (Contractor): dwawrzyniec@mcagplus.com	Email Address (Subcontractor):
Company Address (Contractor): 1966 N Route 1	Company Address (Subcontractor):
City, State and Zip (Contractor): Watseka, IL 60970	City, State and Zip (Subcontractor):
Telephone and Fax (Contractor): 815-549-0955	Telephone and Fax (Subcontractor):
Estimated Start and Completion Dates (Contractor): NA	Estimated Start and Completion Dates (Subcontractor): NA

Note: Upon request, a copy of all written subcontractor agreements must be provided to the OCPO.

Description of Services or Supplies	Total Price of Subcontract for Services or Supplies

The subcontract documents will incorporate all requirements of the Contract awarded to the Contractor as applicable. The subcontract will in no way hinder the Subcontractor/Supplier/Subconsultant from maintaining its progress on any other contract on which it is either a Subcontractor/Supplier/Subconsultant or principal contractor. This disclosure is made with the understanding that the Contractor is not under any circumstances relieved of its abilities and obligations, and is responsible for the organization, performance, and quality of work. This form does not approve any proposed changes, revisions or modifications to the contract approved MBE/WBE Utilization Plan. Any changes to the contract's approved MBE/WBE/Utilization Plan must be submitted to the Office of the Contract Compliance.

McCullough Equipment Inc., dba McCullough Kubota

Contractor

David Wawrzyniec

Name

Account Manager

Title

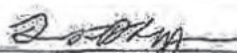

12/17/2025

Prime Contractor Signature

Date

EXHIBIT III

Electronic Payables Program Form

OFFICE OF THE COOK COUNTY COMPTROLLER
ELECTRONIC PAYABLES PROGRAM ("E-PAYABLES")

FOR INFORMATION PURPOSES ONLY

*This document describes the Office of the Cook County Comptroller's Electronic Payables Program ("E-Payables").
If you wish to participate in E-Payables, please contact the Cook County Comptroller's Office, Accounts Payable, 118 N. Clark
Street, Room 500, Chicago, IL 60602.*

DESCRIPTION

To increase payment efficiency and timeliness, we have introduced E-Payables program, a new payment initiative to our accounts payable model. This new initiative utilizes a Visa purchasing card and operates through the Visa payment network. This is County's preferred method of payment and your participation in our Visa purchasing card program will provide mutual benefits both to your organization and ours.

As a vendor, you may experience the following benefits by accepting this new payment type:

- Improved cash flow and accelerated payment
- Reduced paperwork and a more streamlined accounts receivable process
- Elimination of stop payment issues
- Reduced payment delays
- Reduced costs for handling paper checks
- Payments settled directly to your merchant account

There are two options within this initiative:

1. Dedicated Credit Card – "PULL" Settlement

For this option, you will have an assigned dedicated credit card to be used for each payment. You will provide a point of contact within your organization who will keep credit card information on file. Each time a payment is made, you will receive a remittance advice via email detailing the invoices being paid. Each time you receive a remittance advice, you will process payments in the same manner you process credit card transactions today.

2. One-Time Use Credit Card – "SUGA" Settlement

For this option, you will provide a point of contact within your organization who will receive an email notification authorizing you to process payments in the same manner you process credit card transactions today. Each time payment is made, you will receive a remittance advice, via email, detailing the invoices being paid. Also, each time you receive a remittance advice, you will receive a new, unique credit card number. This option is ideal for suppliers who are unable to keep credit card account information on file.

REMAINDER OF PAGE INTENTIONALLY LEFT BLANK

EXHIBIT IV

Preference for Veteran's Business Enterprise and Service-Disabled Veteran's Business Enterprise Form

**VETERAN'S PREFERENCE FOR VBE AND SDVBE
INSTRUCTIONS**

In accordance with Section 34-236(b) of the Cook County Procurement Code, the Chief Procurement Officer ("CPO") shall give a preference of five percent of the amount of the Contract to a Responsible and Responsive Veterans Owned Business Enterprise (VBE) and Service Disabled Veterans Business Enterprise (SDVBE) requesting a preference for Bids. All Bidders who are requesting this preference must complete the form, and attach a copy of its certification. Prior to applying the five percent preference, the CPO must receive approval from the Contract Compliance Director (CCD) that the Bidder is a qualified VBE or SDVBE.

DEFINITIONS

Veteran-owned Business Enterprise (VBE) means a small business (i) that is at least 51 percent owned, controlled and managed by one or more Eligible Veterans or in the case of a corporation, at least 51 percent or more of the stock of which is owned, controlled and managed by one or more Eligible Veterans; (ii) that has its home office in Illinois, as certified by the Contract Compliance Director (CCD) under policies and procedures promulgated by the CCD.

Eligible Veteran means a person who (i) has been either a member of the armed forces of the United States or, while a citizen of the United States, was a member of the armed forces of allies of the United States in time of hostilities with a foreign country and (ii) has served under one or more of the following conditions: (a) the veteran served a total of at least 6 months; (b) the veteran served for the duration of hostilities regardless of the length of the engagement; (c) the veteran was discharged on the basis of hardship; or (d) the veteran was released from active duty because of a service connected disability and was discharged under honorable conditions.

Armed forces of the United States means the United States Army, Navy, Air Force, Marine Corps, Coast Guard or service in active duty as defined under 38 U.S.C. Section 101. Service in the Merchant Marine that constitutes active duty under Section 401 of federal Public Act 95-202 shall also be considered service in the armed forces for purposes of this Division.

Service-Disabled Veteran-owned Business Enterprise (SDVBE) means a small business (i) that is at least 51 percent owned, controlled, and managed by one or more qualified service disabled veterans or in the case of a corporation, at least 51 percent or more of the stock of which is owned, controlled and managed by one or more Service Disabled Veterans; (ii) that has its home office in Illinois, as certified by the CCD under policies and procedures promulgated by the CCD.

Service-Disabled Veteran means an Eligible Veteran who has been found to have 10 percent or more service connected disability by the United States Department of Veterans Affairs or the United States Department of Defense.

Service-connected disability means a disability incurred in the line of duty in the active military, naval or air service as described in 38 U.S.C. 101(16).

Small Business means a small business as defined by the U.S. Small Business Administration, pursuant to the business size standards found in 13 CFR Part 121, as related to the nature of the work the Person seeks to perform on Contracts. A Person is not an eligible small business enterprise in any calendar fiscal year in which its gross receipts, averaged over the Person's previous five fiscal years, exceed the size standards of 13 CFR Part 121.

REQUEST FOR PREFERENCE

Bidder is requesting to receive a preference as a VBE. By requesting this preference, Bidder certifies that it meets the definition of a VBE, as set forth above and has included a copy of its certification.

Bidder is requesting to receive a preference as a SDVBE. By requesting this preference, Bidder certifies that it meets The definition of a SDVBE, as set forth above and has included a copy of its certification.

Bidder (please print or type)

Title

Signature

Date

E-mail address

Phone Number

Subscribed to and sworn before me
this ____ day of _____, 20____.

My commission expires:

X _____
Notary Public Signature

Notary Seal

EXHIBIT V
SOCIAL ENTERPRISE PREFERENCE FORM

SOCIAL ENTERPRISE PREFERENCE

INSTRUCTIONS

In accordance with Section 34-241 of the Cook County Procurement Code, the Chief Procurement Officer ("CPO") shall give a preference of five percent (5%) to a Responsible and Responsive Social Enterprise, as defined by the Cook County Procurement Code, requesting a preference for Bids. All Bidders who are requesting this preference must fully complete this form and supply all requested information. Failure to provide fully comply with these instructions will result in the preference not being granted. The CPO reserves the right to request additional information to ascertain a Bidder's status as a Social Enterprise.

DEFINITIONS

County Marketplace means the six-county region, currently the counties of Cook, DuPage, Kane, Lake, McHenry, and Will. Disadvantaged refers to individuals who are mentally, physically, economically, or educationally disadvantaged, including, but not limited to, individuals who are living below the poverty line, developmentally disabled, mentally ill, substance abusers, recovering substance abusers, elderly and in need of hospice care, gang members, on welfare, or people with arrest or conviction records.

Earned Revenue Strategies means revenue realized by a non-profit private sector entity, or a business unit of a private sector entity excluding government grants, government contracts and philanthropic support.

Social Enterprise means a Person which has its principal place of business and a majority of its regular, full-time work force located within the County Marketplace on the date a bid is submitted, and which is:

- 1. An Illinois benefit corporation subject to the Benefit Corporation Act (805 ILCS 40/1 et seq.);
2. An Illinois low-profit limited liability company subject to Section 1-26 of the Limited Liability Company Act (805 ILCS 180/1-26); or
3. A nonprofit entity, a private-sector entity, or any business unit of a private sector entity which maintains separate books and records which (a) uses earned revenue strategies, either exclusively as a business or as a significant part (at least 51%) of earned revenue, and (b) directly addresses social needs either (1) through its goods and/or services or (2) by employing a workforce of which 51% are disadvantaged, or (3) both. At any time, upon request of the County, for a period of three (3) years following the termination of the contract, Bidder must provide documentation that it meets the requirements of this provision.

REQUEST FOR PREFERENCE

- Requesting Social Enterprise Preference as an Illinois Benefit Corporation.
Requesting Social Enterprise Preference as an Illinois Low Profit Limited Liability Company ("L3C").
Requesting Social Enterprise Preference as a social enterprise that is neither a Benefit Corporation or an L3C, but uses earned revenue strategies...

Bidder (please print or type)

Title

Signature

Date

Email address

Phone Number

Subscribed to and sworn before me. This ___ day of ____, 20__.

My Commission Expires: _____

Notary Public Signature

Notary Seal

EXHIBIT VI

Veteran's Workplace Preference Public Works Contracts Form

**AFFIDAVIT
VETERAN'S WORKPLACE PREFERENCE PUBLIC WORKS CONTRACTS**

INSTRUCTIONS

In accordance with Section 34-236(a) of the Cook County Procurement Code, the Chief Procurement Officer ("CPO") shall give a preference of one percent of the amount of the Contract to a Responsible and Responsive Contractor for a Public Works Contract when such Contractor has committed by affidavit to utilize Eligible Veterans for at least five percent of the hours worked under such Contract. Failure to utilize Eligible Veterans in accordance with the affidavit will result in breach of contract. All Bidders who are requesting this preference must complete this Affidavit.

DEFINITIONS

Eligible Veteran means a person who (i) has been either a member of the armed forces of the United States or, while a citizen of the United States, was a member of the armed forces of allies of the United States in time of hostilities with a foreign country and (ii) has served under one or more of the following conditions: (a) the veteran served a total of at least 6 months; (b) the veteran served for the duration of hostilities regardless of the length of the engagement; (c) the veteran was discharged on the basis of hardship; or (d) the veteran was released from active duty because of a service connected disability and was discharged under honorable conditions.

Armed forces of the United States means the United States Army, Navy, Air Force, Marine Corps, Coast Guard or service in active duty as defined under 38 U.S.C. Section 101. Service in the Merchant Marine that constitutes active duty under Section 401 of federal Public Act 95-202 shall also be considered service in the armed forces for purposes of this Division.

Public Works means all fixed works constructed or demolished by the County, or paid for wholly or in part out of public funds administered by the County. "Public Works" as defined herein includes all projects financed in whole or in part with bonds, grants, loans, or other funds made available by or through federal or State government, or the County. "Public Works" does not include projects undertaken by the owner at an owner-occupied single-family residence or at an owner-occupied unit of a multifamily residence. "Public Works" includes any maintenance, repair, assembly, or disassembly work performed on equipment whether owned, leased, or rented.

I, _____, being first duly sworn, do depose and state as follows:

1. I am the authorized representative and I have the authority to make this Affidavit for and on behalf of the Bidder.
2. The Bidder is requesting the CPO grant a preference of one percent of the amount of the Contract in accordance with Section 34-236(a) of the Cook Procurement Code, as set forth above.
3. In accordance with the Cook County Procurement Code, the Bidder shall commit to utilize Eligible Veterans for at least five percent of the hours worked under the Contract. The Eligible Veterans must be employed directly by the Bidder.
4. The Bidder shall be solely responsible for requesting all persons to provide Bidder with appropriate documentation to ensure that such person(s) is an Eligible Veteran, as defined above. Bidder certifies, that by seeking this preference, it shall maintain appropriate documentation, including payroll records, which show the number of hours worked by Eligible Veterans.
5. The Bidder certifies, affirms and acknowledges that the failure to utilize Eligible Veterans in accordance with this Affidavit will result in a breach of contract, which will allow the County to seek all rights and remedies as set forth in the Contract and any other appropriate remedies available in equity or at law.

Bidder (please print or type)

Title

Signature

Date

E-mail address

Phone Number

Subscribed to and sworn before me
this ____ day of _____ 20 ____.

My commission expires:

X _____
Notary Public Signature

Notary Seal

EXHIBIT VII

Preference for Businesses Owned by People with Disabilities Form

N/A

Preference for Businesses Owned by People with Disabilities Form

INSTRUCTIONS

In accordance with Section 34-236(b) of the Cook County Procurement Code, the Chief Procurement Officer ("CPO") shall give a preference of **five percent of the amount of the Contract** to a Responsible and Person with Disabilities Owned Business Enterprise ("PDBE") requesting a preference for Bids. All Bidders who are requesting this preference must complete the form and attach a copy of its certification. Prior to applying the five percent preference, the CPO must receive approval from the Contract Compliance Director (CCD) that the Bidder is a qualified PDBE.

DEFINITIONS

Persons with Disabilities Owned Business Enterprise (PDBE) means a small business (i) that is at least 51 percent owned, controlled and managed by one or more Persons with a Disability; or in the case of a corporation, at least 51 percent or more of the stock of which is owned, controlled, and managed by one or more Persons with a Disability; (ii) that has its home office in Illinois, as certified by the CCD under policies and procedures promulgated by the CCD.

Disability or Disabled means, with respect to an individual, a physical or mental impairment that substantially limits one or more of the major life activities of the individual, a record of physical or mental impairment that substantially limits one or more of the major life activities of the individual, or being regarded as an individual with a physical or mental impairment that substantially limits one or more of the major life activities of the individual.

Small Business means a small business as defined by the U.S. Small Business Administration, pursuant to the business size standards found in 13 CFR Part 121, as related to the nature of the work the Person seeks to perform on Contracts. A Person is not an eligible small business enterprise in any calendar fiscal year in which its gross receipts, averaged over the Person's previous five fiscal years, exceed the size standards of 13 CFR Part 121.

REQUEST FOR PREFERENCE

Bidder is requesting to receive a preference as a PDBE. By requesting this preference, Bidder certifies that it meets the definition of a PDBE, as set forth above and has included a copy of its certification.

Bidder (please print or type)

Title

Signature

Date

E-mail address

Phone Number

Subscribed to and sworn before me
this ____ day of _____, 20____.

My commission expires:

X _____
Notary Public Signature

Notary Seal

EXHIBIT VIII

Board Approval (If Applicable)



Board of Commissioners of Cook County

118 North Clark Street
Chicago, IL

Legislation Details

File #: 26-0302 Version: 1 Name: Contract for Tractor Mowers with Attachments - co. no. 2457-10011R
 Type: Contract Status: Approved
 File created: 12/1/2025 In control: Transportation Committee
 On agenda: 1/15/2026 Final action: 2/5/2026
 Title: PROPOSED CONTRACT

Department(s): Transportation and Highways

Vendor: McCullough Equipment Inc., d/b/a McCullough Kubota, Frankfort, Illinois

Request: Authorization for the Chief Procurement Officer to enter into and execute

Good(s) or Service(s): Tractor Mowers with Attachments

Contract Value: \$1,206,696.00

Contract period: 2/14/2026 - 2/13/2028 with one (1), one (1) year renewal option

Contract Utilization: The Contract-specific goal set on this Contract is Zero.

Potential Fiscal Year Budget Impact: FY 2026 \$960,000.00, FY 2027 \$123,348.00, FY 2028 \$123,348.00

Accounts: Capital Equipment: 11569.1500.21120.560155

Contract Number(s): 2457-10011R

Summary: The Department of Transportation and Highways respectfully requests approval of proposed Contract between the County and McCullough Equipment Inc., d/b/a McCullough Kubota, Frankfort, Illinois. This Contract will provide for the capital purchase of twelve (12) new Tractor Mowers with Attachments. The new equipment will be used for mowing grass along Cook County roadways.

The new Tractor Mowers with Attachments will replace Tractor Mowers that are beyond their useful life. The cost to maintain the current Tractor Mowers is extensive. The new Tractor Mowers with Attachments will provide safe, reliable, and efficient equipment for the Maintenance Bureau.

The vendor was selected pursuant to a publicly advertised Invitation for Bids (IFB) in accordance with the Cook County Procurement Code. McCullough Equipment Inc. d/b/a McCullough Kubota was the lowest, responsive and responsible bidder.

Sponsors:

Indexes: JENNIFER (SIS) KILLEN, Superintendent, Department of Transportation and Highways

Code sections:

Attachments:

Date	Ver.	Action By	Action	Result
2/5/2026	1	Board of Commissioners	approve	Pass

2/4/2026	1	Transportation Committee		
1/15/2026	1	Board of Commissioners	refer	Pass

EXHIBIT IX

Minority-Owned Business Enterprise and Women-Owned Business Enterprise Utilization Plan



COOK COUNTY
OFFICE OF THE
Chief Procurement
Officer

161 N. Clark
Suite 2300
Chicago, Illinois 60601

Date: December 16, 2025

TO: Raffi Sarrafian, Chief Procurement Officer
Office of the Chief Procurement Officer

FROM: JEANETTA CARDINE
Jeanetta Cardine, Deputy Director
Compliance Center of Excellence
Center of Business Enterprise Development

RE: Contract No. 2457-10011R
Tractor Mowers with Attachments
Department of Transportation and Highways (DOTH)
Competitive Bid: Goods and Services
Contractor: McCullough Equipment, Inc. dba McCullough Kubota
Contract Value: \$1,206,696.00
Contract Term: 2/14/26 – 2/13/28 plus one (1) one (1) year renewal option
Participation Goal: 0% MBE & 0% WBE

The Center of Business Enterprise Development is in receipt of the above-referenced contract for goods and services and has determined a 0% MBE and 0% WBE participation goal was recommended and does not require the Center of Business Enterprise Development to review for MBE/WBE compliance with the Minority- and Women-owned Business Enterprises (MBE/WBE) Ordinance.

JC/db

CC: Angelique Randle, OCPO
Randy Piscitelli, DOTH



MBE/WBE UTILIZATION PLAN - FORM 1

BIDDER/PROPOSER HEREBY STATES that all MBE/WBE firms included in this Plan are certified MBEs/WBEs by at least one of the entities listed in the General Conditions – Section 19.

I. BIDDER/PROPOSER MBE/WBE STATUS: (check the appropriate line)

- Bidder/Proposer is a certified MBE or WBE firm. (If so, attach copy of current Letter of Certification)
- Bidder/Proposer is a Joint Venture and one or more Joint Venture partners are certified MBEs or WBEs. (If so, attach copies of Letter(s) of Certification, a copy of Joint Venture Agreement clearly describing the role of the MBE/WBE firm(s) and its ownership interest in the Joint Venture and a completed Joint Venture Affidavit.
- Bidder/Proposer is not a certified MBE or WBE firm, nor a Joint Venture with MBE/WBE partners, but will utilize MBE and WBE firms either directly or indirectly in the performance of the Contract. (If so, complete Sections II below and the Letter(s) of Intent – Form 2).

II. **Direct Participation of MBE/WBE Firms** **Indirect Participation of MBE/WBE Firms**

NOTE: Where goals have not been achieved through direct participation, Bidder/Proposer shall include documentation outlining efforts to achieve Direct Participation at the time of Bid/Proposal submission. Indirect Participation will only be considered after all efforts to achieve Direct Participation have been exhausted. Only after written documentation of Good Faith Efforts is received will Indirect Participation be considered.

MBEs/WBEs that will perform as subcontractors/suppliers/consultants include the following:

MBE/WBE Firm: _____
 Address: _____
 E-mail: _____
 Contact Person: _____ Phone: _____
 Dollar Amount Participation: \$ _____
 Percent Amount of Participation: _____ %

*Letter of Intent attached? Yes No
 *Current Letter of Certification attached? Yes No

MBE/WBE Firm: _____
 Address: _____
 E-mail: _____
 Contact Person: _____ Phone: _____
 Dollar Amount Participation: \$ _____
 Percent Amount of Participation: _____ %

*Letter of Intent attached? Yes No
 *Current Letter of Certification attached? Yes No

Attach additional sheets as needed.

*** Letter(s) of Intent and current Letters of Certification must be submitted at the time of bid.**



MBE/WBE LETTER OF INTENT - FORM 2

M/WBE Firm: _____

Certifying Agency: _____

Contact Person: _____

Certification Expiration Date: _____

Address: _____

Ethnicity: _____

City/State: _____ Zip: _____

Bid/Proposal/Contract #: _____

Phone: _____ Fax: _____

FEIN #: _____

Email: _____

Participation: Direct Indirect

Will the M/WBE firm be subcontracting any of the goods or services of this contract to another firm?

No Yes – Please attach explanation. Proposed Subcontractor(s): _____

The undersigned M/WBE is prepared to provide the following Commodities/Services for the above named Project/ Contract: *(If more space is needed to fully describe M/WBE Firm's proposed scope of work and/or payment schedule, attach additional sheets)*

Indicate the **Dollar Amount, Percentage**, and the **Terms of Payment** for the above-described Commodities/ Services:

THE UNDERSIGNED PARTIES AGREE that this Letter of Intent will become a binding Subcontract Agreement for the above work, conditioned upon (1) the Bidder/Proposer's receipt of a signed contract from the County of Cook; (2) Undersigned Subcontractor remaining compliant with all relevant credentials, codes, ordinances and statutes required by Contractor, Cook County, and the State to participate as a MBE/WBE firm for the above work. The Undersigned Parties do also certify that they did not affix their signatures to this document until all areas under Description of Service/ Supply and Fee/Cost were completed.

Signature (M/WBE)

Signature (Prime Bidder/Proposer)

Print Name

Print Name

Firm Name

Firm Name

Date

Date

Subscribed and sworn before me
this ____ day of _____, 20__.

Subscribed and sworn before me
this ____ day of _____, 20__.

Notary Public _____

Notary Public _____

SEAL

SEAL

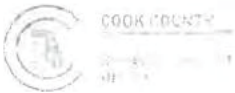

PETITION FOR PARTIAL OR FULL WAIVER – FORM 3

Bidder/Proposer: McCullough Equipment, Inc. dba McCullough Kubota

Contract No./Title: 2457-10011R Tractor Mowers with Attachements

A. BIDDER/PROPOSER HEREBY REQUESTS:

- | | |
|---|---|
| <input checked="" type="checkbox"/> FULL MBE WAIVER | <input type="checkbox"/> PARTIAL MBE WAIVER |
| <input checked="" type="checkbox"/> FULL WBE WAIVER | <input type="checkbox"/> PARTIAL WBE WAIVER |
| <input checked="" type="checkbox"/> FULL DBE WAIVER | <input type="checkbox"/> PARTIAL DBE WAIVER |

B. REASON FOR PARTIAL/FULL WAIVER REQUEST:

Bidder/Proposer shall check each item applicable to its overall reason for a waiver request. Additionally, supporting documentation shall be submitted with this request.

- (1) Lack of sufficient qualified MBEs and/or WBEs capable of providing the goods or services required by the contract.
- (2) The specifications and necessary requirements for performing the contract make it impossible or economically infeasible to divide the contract to enable the contractor to utilize MBEs and/or WBEs in accordance with the applicable participation.
- (3) Price(s) quoted by potential MBEs and/or WBEs are above competitive levels and increase cost of doing business and would make acceptance of such MBE and/or WBE bid economically impracticable, taking into consideration the percentage of total contract price represented by such MBE and/or WBE bid.
- (4) There are other relevant factors making it impossible or economically infeasible to utilize MBE and/or WBE firms.

GOOD FAITH EFFORT TRANSPARENCY REPORT

C. GOOD FAITH EFFORTS TO OBTAIN PARTICIPATION (attach sheets as necessary as Schedule 1)

Bidder/Proposer shall explain and detail the following Good Faith Efforts undertaken to meet Cook County's contract specific goals.

1. Please attach to this form a detailed list of any and all PCEs, stating the PCE certification (MBE and/or WBE as defined by the Cook County Municipal Code) and with whom from the contacted PCEs the Bidder/Proposer engaged, contacted, and/or communicated with in the County's Market Place;
Timelines:
 - a. When the Bidder/Proposer knew of the bid;
 - b. When the Bidder/Proposer contacted the PCE(s);
 - c. When the Bidder/Proposer formulated its bid and utilization plan;
and
 - d. When was the bid request due date.

2. The number of timely attempts to contact PCEs providing the type of supplies, equipment, goods, and/or services required for the Procurement, including but not limited to;
 - a. Dates of each contact attempt for each contacted PCE;
 - b. Whom, if anyone, the Bidder/Proposer communicated and/or corresponded (including written, virtual, digital, electronic, and other feasible methods of communication);
 - c. The number of unsuccessful attempts to communicate or correspond with PCEs; and
 - d. Attach copies of all solicitations to contacted PCEs.

3. How the Bidder/Proposer proposed to divide the procurement requirements into small tasks and/or quantities into economically feasible units to promote PCE participation.

4. Whether and to what degree the requesting party will endeavor to maximize indirect participation.

5. Detailed explanation of use, if any, of the Center of Business Enterprise Development Compliance services and staff.

6. Detailed explanation of timely notification and usage of services and assistance provided by community, minority, and/or women business organizations.

7. Attach any other documentation relative to Good Faith Efforts in complying with MBE and WBE participation.

GOOD FAITH EFFORT TRANSPARENCY REPORT

By signing below, I affirm under penalty of perjury the information provided in the Petition for Full or Partial Waiver/Good Faith Effort Transparency Report is truthful, accurate, and complete, to the best of my knowledge and capacity. I agree any finding of false, fraudulent, and/or otherwise misleading information will automatically disqualify the request for a waiver and County's Center of Business Enterprise Development reserves the right to pursue additional actions and/or remedies against the requesting Bidder/Proposer.

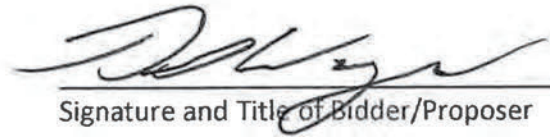
	Account Manager	11/04/2025
Signature and Title of Bidder/Proposer	Title	Date



Cook County MBE/WBE Non-Construction Certification Reciprocal Affidavit

Firm Name _____

Address _____ City _____

County _____ State _____ Zip _____

Phone (____) _____ Email _____

I _____
(Authorized Representative) (Print Title)

of _____ do hereby affirm:
(Name of Firm)

1) _____ is a Minority and/or Women Business Enterprise currently
(Name of Firm)
certified by the City of Chicago as: [] Black- [] Hispanic- [] Asian- [] Woman-owned business.

2) With respect to _____, the personal net worth of the qualifying
(Name of Firm)
(51%) individual(s) does not exceed \$2,767,082.23, excluding the individual's ownership interest in the M/WBE firm and the equity of the owner's primary residence, and otherwise meets the requirements of Chapter 34, Article IV of the Cook County Procurement Code. (As per Section 34-263 of the Cook County Procurement Code, an individual's personal net worth includes only his or her own Share of assets held jointly or as community/marital property with the individual's spouse.)

3) The average annual gross receipts of _____,
(Name of Firm)
as derived from tax filings over the five most recent years, does not exceed the Small Business Size Standards published by the U.S. Small Business Administration found in Title 13, Code of Federal Regulations, Part 121.
()

Upon penalty of perjury, I _____ affirm that, to the best of my knowledge
(Authorized Representative)
and belief, the information herein is true and accurate.

Signature _____ Title _____ Date _____

Subscribed and sworn to before me this _____ day of _____ / _____
(Month) (Year)

(Notary's Signature)

Notary's Seal

My Commission Expires _____

PLEASE NOTE: This affidavit is good for a period of one year from the date of sworn signature. Any changes to your firm within that year may require a new form.

EXHIBIT X

Certificate of Insurance

A certificate of insurance is not required to be submitted with the Bid. The apparent low Bidder shall provide a certificate of insurance that meets the required insurance and amounts of coverage, when requested by the County. Failure to provide a certificate of insurance meeting the required coverages and amounts of coverages may result in the Bidder being removed from consideration for award.



CERTIFICATE OF LIABILITY INSURANCE

DATE (MM/DD/YYYY)
01/30/2026

THIS CERTIFICATE IS ISSUED AS A MATTER OF INFORMATION ONLY AND CONFERS NO RIGHTS UPON THE CERTIFICATE HOLDER. THIS CERTIFICATE DOES NOT AFFIRMATIVELY OR NEGATIVELY AMEND, EXTEND OR ALTER THE COVERAGE AFFORDED BY THE POLICIES BELOW. THIS CERTIFICATE OF INSURANCE DOES NOT CONSTITUTE A CONTRACT BETWEEN THE ISSUING INSURER(S), AUTHORIZED REPRESENTATIVE OR PRODUCER, AND THE CERTIFICATE HOLDER.

IMPORTANT: If the certificate holder is an ADDITIONAL INSURED, the policy(ies) must have ADDITIONAL INSURED provisions or be endorsed. If SUBROGATION IS WAIVED, subject to the terms and conditions of the policy, certain policies may require an endorsement. A statement on this certificate does not confer rights to the certificate holder in lieu of such endorsement(s).

PRODUCER Sentry Insurance 1800 North Point Drive Stevens Point, WI 54481	CONTACT NAME: Sentry Customer Service	FAX (A/C, No): 800-514-7191
	PHONE (A/C, No, Ext): 800-473-6879	EMAIL ADDRESS: businessproducts_direct@sentry.com
INSURER(S) AFFORDING COVERAGE		NAIC#
INSURER A : Sentry Select Insurance Company		21180
INSURED McCullough Implement DBA McCullough Kubota 7225 Grand Ave Gurnee, IL 60031-5270	INSURER B :	
	INSURER C :	
	INSURER D :	
	INSURER E :	
	INSURER F :	

COVERAGES CERTIFICATE NUMBER: 4493841 REVISION NUMBER:

THIS IS TO CERTIFY THAT THE POLICIES OF INSURANCE LISTED BELOW HAVE BEEN ISSUED TO THE INSURED NAMED ABOVE FOR THE POLICY PERIOD INDICATED, NOTWITHSTANDING ANY REQUIREMENT, TERM OR CONDITION OF ANY CONTRACT OR OTHER DOCUMENT WITH RESPECT TO WHICH THIS CERTIFICATE MAY BE ISSUED OR MAY PERTAIN, THE INSURANCE AFFORDED BY THE POLICIES DESCRIBED HEREIN IS SUBJECT TO ALL THE TERMS, EXCLUSIONS AND CONDITIONS OF SUCH POLICIES. LIMITS SHOWN MAY HAVE BEEN REDUCED BY PAID CLAIMS.

INSR LTR	TYPE OF INSURANCE	ADDL INSR	SUBR WVD	POLICY NUMBER	POLICY EFF (MM/DD/YYYY)	POLICY EXP (MM/DD/YYYY)	LIMITS		
A	<input checked="" type="checkbox"/> COMMERCIAL GENERAL LIABILITY			A0253806006	08/01/2025	08/01/2026	EACH OCCURRENCE	\$ 1,000,000	
	<input type="checkbox"/> CLAIMS-MADE <input checked="" type="checkbox"/> OCCUR						DAMAGE TO RENTED PREMISES (Ea occurrence)	\$ 500,000	
	GEN'L AGGREGATE LIMIT APPLIES PER:							MED EXP (Any one person)	\$ 5,000
	<input checked="" type="checkbox"/> POLICY <input type="checkbox"/> PRO-JECT <input type="checkbox"/> LOC						PERSONAL & ADV INJURY	\$ 1,000,000	
	OTHER:							GENERAL AGGREGATE	\$ 3,000,000
								PRODUCTS - COMP/OP AGG	\$ 2,000,000
									\$
A	AUTOMOBILE LIABILITY			A0253806001	08/01/2025	08/01/2026	COMBINED SINGLE LIMIT (Ea accident)	\$ 1,000,000	
	<input checked="" type="checkbox"/> ANY AUTO						BODILY INJURY (Per person)	\$	
	<input type="checkbox"/> OWNED AUTOS ONLY <input type="checkbox"/> SCHEDULED AUTOS						BODILY INJURY (Per accident)	\$	
	<input type="checkbox"/> HIRED AUTOS ONLY <input type="checkbox"/> NON-OWNED AUTOS ONLY						PROPERTY DAMAGE (Per accident)	\$	
									\$
A	<input checked="" type="checkbox"/> UMBRELLA LIAB <input checked="" type="checkbox"/> OCCUR			A0253806008	08/01/2025	08/01/2026	EACH OCCURRENCE	\$ 5,000,000	
	<input checked="" type="checkbox"/> EXCESS LIAB <input type="checkbox"/> CLAIMS-MADE						AGGREGATE	\$ 15,000,000	
	<input type="checkbox"/> DED <input type="checkbox"/> RETENTION \$						PRODUCTS - COMP/OP AGG	\$ 15,000,000	
								PER STATUTE OTH-ER	
A	WORKERS COMPENSATION AND EMPLOYERS' LIABILITY			N/A	N/A	N/A	E.L. EACH ACCIDENT	\$	
	ANY PROPRIETOR/PARTNER/EXECUTIVE OFFICER/MEMBER EXCLUDED? (Mandatory in NH)						E.L. DISEASE - EA EMPLOYEE	\$	
	If yes, describe under DESCRIPTION OF OPERATIONS below						E.L. DISEASE - POLICY LIMIT	\$	
								Employee Benefits Occurrence Limit	\$ 500,000
A	ERRORS & OMISSIONS			A0253806005	08/01/2025	08/01/2026	Errors & Omissions Annual Aggregate Limit	\$ 1,000,000	
							Deductible	\$ 1,000	
		All Other Errors & Omissions Occurrence Limit	\$ 250,000						
						Annual Aggregate Limit	\$ 500,000		
						Deductible	\$ 5,000		

DESCRIPTION OF OPERATIONS / LOCATIONS / VEHICLES (ACORD 101, Additional Remarks Schedule, may be attached if more space is required)

Refer to attached

CERTIFICATE HOLDER

Cook County Highway Department
69 W Washington St Fl 30
Chicago, IL 60602-3134

CANCELLATION

SHOULD ANY OF THE ABOVE DESCRIBED POLICIES BE CANCELLED BEFORE THE EXPIRATION DATE THEREOF, NOTICE WILL BE DELIVERED IN ACCORDANCE WITH THE POLICY PROVISIONS.

AUTHORIZED REPRESENTATIVE



AGENCY CUSTOMER ID: XXXXXX3129

LOC #: _____

ADDITIONAL REMARKS SCHEDULEPage 2 of 2

AGENCY Brady Hammon		NAMED INSURED McCullough Implement DBA McCullough Kubota
POLICY NUMBER A0253806006		
CARRIER Sentry Select Insurance Company	NAIC CODE 21180	EFFECTIVE DATE: 08/01/2025

ADDITIONAL REMARKS

THIS ADDITIONAL REMARKS FORM IS A SCHEDULE TO ACORD FORM,

FORM NUMBER: ACORD 25 FORM TITLE: Certificate of Liability Insurance**Certificate Details**

Additional Insured status, Primary & Noncontributory and Waiver of transfer of rights applies per the terms and conditions of the policy when required in written contract or written agreement.



CERTIFICATE OF LIABILITY INSURANCE

DATE (MM/DD/YYYY)
01/30/2026

THIS CERTIFICATE IS ISSUED AS A MATTER OF INFORMATION ONLY AND CONFERS NO RIGHTS UPON THE CERTIFICATE HOLDER. THIS CERTIFICATE DOES NOT AFFIRMATIVELY OR NEGATIVELY AMEND, EXTEND OR ALTER THE COVERAGE AFFORDED BY THE POLICIES BELOW. THIS CERTIFICATE OF INSURANCE DOES NOT CONSTITUTE A CONTRACT BETWEEN THE ISSUING INSURER(S), AUTHORIZED REPRESENTATIVE OR PRODUCER, AND THE CERTIFICATE HOLDER.

IMPORTANT: If the certificate holder is an ADDITIONAL INSURED, the policy(ies) must have ADDITIONAL INSURED provisions or be endorsed. If SUBROGATION IS WAIVED, subject to the terms and conditions of the policy, certain policies may require an endorsement. A statement on this certificate does not confer rights to the certificate holder in lieu of such endorsement(s).

PRODUCER Sentry Insurance 1800 North Point Drive Stevens Point, WI 54481	CONTACT NAME: Sentry Customer Service
	PHONE (A/C, No, Ext): 800-473-6879 FAX (A/C, No): 800-514-7191
	EMAIL ADDRESS: businessproducts_direct@sentry.com
	INSURER(S) AFFORDING COVERAGE
	INSURER A : Sentry Select Insurance Company NAIC# 21180
INSURED McCullough Implement DBA McCullough Kubota 7225 Grand Ave Gurnee, IL 60031-5270	INSURER B :
	INSURER C :
	INSURER D :
	INSURER E :
	INSURER F :

COVERAGES

CERTIFICATE NUMBER: 4493841

REVISION NUMBER:

THIS IS TO CERTIFY THAT THE POLICIES OF INSURANCE LISTED BELOW HAVE BEEN ISSUED TO THE INSURED NAMED ABOVE FOR THE POLICY PERIOD INDICATED. NOTWITHSTANDING ANY REQUIREMENT, TERM OR CONDITION OF ANY CONTRACT OR OTHER DOCUMENT WITH RESPECT TO WHICH THIS CERTIFICATE MAY BE ISSUED OR MAY PERTAIN, THE INSURANCE AFFORDED BY THE POLICIES DESCRIBED HEREIN IS SUBJECT TO ALL THE TERMS, EXCLUSIONS AND CONDITIONS OF SUCH POLICIES. LIMITS SHOWN MAY HAVE BEEN REDUCED BY PAID CLAIMS.

INSR LTR	TYPE OF INSURANCE	ADDL INSR	SUBR WVD	POLICY NUMBER	POLICY EFF (MM/DD/YYYY)	POLICY EXP (MM/DD/YYYY)	LIMITS
	<input type="checkbox"/> CLAIMS-MADE <input type="checkbox"/> OCCUR <hr/> GEN'L AGGREGATE LIMIT APPLIES PER: <input type="checkbox"/> POLICY <input type="checkbox"/> PRO-JECT <input type="checkbox"/> LOC OTHER:						EACH OCCURRENCE \$ DAMAGE TO RENTED PREMISES (Ea occurrence) \$ MED EXP (Any one person) \$ PERSONAL & ADV INJURY \$ GENERAL AGGREGATE \$ PRODUCTS - COMP/OP AGG \$ \$
	AUTOMOBILE LIABILITY <input type="checkbox"/> ANY AUTO <input type="checkbox"/> OWNED AUTOS ONLY <input type="checkbox"/> SCHEDULED AUTOS <input type="checkbox"/> HIRED AUTOS ONLY <input type="checkbox"/> NON-OWNED AUTOS ONLY						COMBINED SINGLE LIMIT (Ea accident) \$ BODILY INJURY (Per person) \$ BODILY INJURY (Per accident) \$ PROPERTY DAMAGE (Per accident) \$ \$
	<input type="checkbox"/> UMBRELLA LIAB <input type="checkbox"/> OCCUR <input type="checkbox"/> EXCESS LIAB <input type="checkbox"/> CLAIMS-MADE DED RETENTION \$						EACH OCCURRENCE \$ AGGREGATE \$ \$
	WORKERS COMPENSATION AND EMPLOYERS' LIABILITY ANY PROPRIETOR/PARTNER/EXECUTIVE OFFICER/MEMBER EXCLUDED? (Mandatory in NH) If yes, describe under DESCRIPTION OF OPERATIONS below						<input type="checkbox"/> PER STATUTE <input type="checkbox"/> OTH-ER E.L. EACH ACCIDENT \$ E.L. DISEASE - EA EMPLOYEE \$ E.L. DISEASE - POLICY LIMIT \$
A	Cyber Liability and Data Breach Response		N / A	A0253806007	08/01/2025	08/01/2026	Policy Aggregate Limit of Liability \$ 1,000,000 Retention \$ 25,000

DESCRIPTION OF OPERATIONS / LOCATIONS / VEHICLES (ACORD 101, Additional Remarks Schedule, may be attached if more space is required)

Refer to attached

CERTIFICATE HOLDER

Cook County Highway Department
69 W Washington St Fl 30
Chicago, IL 60602-3134

CANCELLATION

SHOULD ANY OF THE ABOVE DESCRIBED POLICIES BE CANCELLED BEFORE THE EXPIRATION DATE THEREOF, NOTICE WILL BE DELIVERED IN ACCORDANCE WITH THE POLICY PROVISIONS.

AUTHORIZED REPRESENTATIVE



AGENCY CUSTOMER ID: XXXXXX3129

LOC #: _____

ADDITIONAL REMARKS SCHEDULEPage 2 of 2

AGENCY Brady Hammon		NAMED INSURED McCullough Implement DBA McCullough Kubota	
POLICY NUMBER A0253806007			
CARRIER Sentry Select Insurance Company	NAIC CODE 21180	EFFECTIVE DATE: 08/01/2025	

ADDITIONAL REMARKS

THIS ADDITIONAL REMARKS FORM IS A SCHEDULE TO ACORD FORM,

FORM NUMBER: ACORD 25 FORM TITLE: Certificate of Liability Insurance**Certificate Details**

Additional Insured status, Primary & Noncontributory and Waiver of transfer of rights applies per the terms and conditions of the policy when required in written contract or written agreement.

EXHIBIT XI

Addenda Acknowledgment Form (If Applicable)



**COOK COUNTY
OFFICE OF THE CHIEF PROCUREMENT OFFICER**

69 West Washington, Suite 3000
Chicago, Illinois 60602
(312) 603-5370

ADDENDA ACKNOWLEDGEMENT FORM

IMPORTANT NOTICE: Bidders shall acknowledge receipt of any addenda issued on the spaces provided below and submit this form with its Bid. Failure to acknowledge receipt of any addenda issued and submittal of this form may render the Bid non-responsive.

Bid No.: 2557-10011R

Project Name: Tractor Mowers with Attachments

- Addendum No. 1
- Addendum No. 2
- Addendum No. 3
- Addendum No. 4
- Addendum No. 5
- Other: _____
- N/A (No Addenda Issued)

Signature:  Date: 12/17/2025

Name: David Wawrzyniec Title: Account Manager

Company: McCullough Equipment Inc., dba McCullough Kubota

Address: 1966 N State Route 1 Watseka, IL 60970

EXHIBIT XII

Bid Page

Bidders shall enter their bid pricing directly into Bonfire. See Exhibit I for instructions.

McCullough Implement Company D/B/A McCullough Kubota						
Item #	Description	Commodity Code (UNSPSC)	Unit of	Estimated Quantity	Unit Price	Total Cost
1	New Holland Workmaster 70 Tractor Mower or equal	25101604	Each	12	\$ 53,900.00	\$ 646,800.00
2	Alamo Switchblade six foot sickle bar or equal	25101604	Each	12	\$ 33,220.00	\$ 398,640.00
3	Land Pride RCF 2772 or equal ROTARY CUTTER MOWER BOX	25101604	Each	12	\$ 4,959.00	\$ 59,508.00
4	Land Pride RCF 3096 or equal Rotary Mower Box	25101604	Each	12	\$ 8,479.00	\$ 101,748.00
				Total		\$ 1,206,696.00

RCF30 SERIES ROTARY CUTTERS

DUAL SPINDLE: 40-110 HP | Cat. 1, 2 & 3



Performance in a Medium-Duty Cutter.

The RCF30 Series is the perfect medium-duty cutter for pastures and roadside applications. Available in 3-Point, semi-mount or pull-type, the RCF30 features a 2-1/2" cutting capacity and 1/4" side skirts. Plus, every RCF30 comes with the rugged dependability that Land Pride Rotary Cutters are known for.

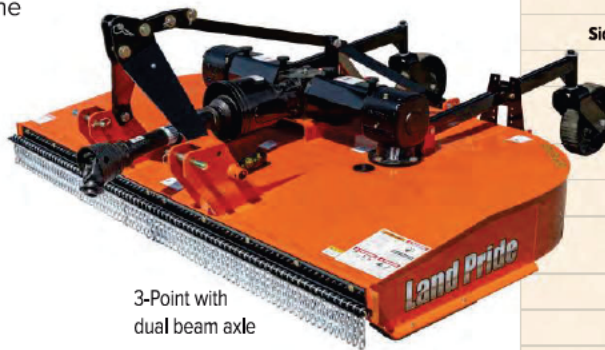

3-Point with dual beam axle

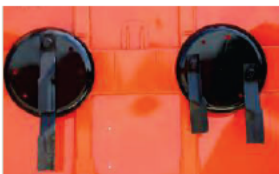

Dual heavy-duty standard stump jumpers aide in sliding over obstructions which helps protect the gearbox output shaft.



Splined rubber flex-couplers between the center and outboard gearboxes protect the driveline and gearboxes from shock loads.



	RCF3096	RCF3010
Horsepower	3-Pt: 50-110 HP Semi & Pull: 40-110 HP	3-Pt: 60-110 HP Semi & Pull: 50-110 HP
Hitch	Cat. 1 & 2 QH	Cat. 2 & 3 QH
Working Width (cm)	8' (244)	10' (305)
Overall Width	8'7"	10'6-1/2"
Overall Length (3-Pt w/Twin Beam Axle)	102"	122"
Weight - lb (kg) (3-Pt w/Twin Beam Axle)	1,587 (720)	2,004 (909)
Deck Thickness	10 Gauge	
Side Skirt Thickness	1/4"	
Gearbox Rating[^]	Outboard: 130 HP, Center 210 HP	
Gearbox	540 RPM	540 RPM or 1,000 RPM
Cutting Height	2" - 12"	
Cutting Capacity	2-1/2" Diameter	
Shielding	Front: Rubber, Chain or Double Chain Rear: Rubber, Chain or Double Chain	
Skids	Replaceable	
Deck Height	11-1/4"	11-1/2"
Blades	1/2" x 4" Heat Treated Alloy Steel Free Swinging Blades	
Blade Tip Speed	16,360 fpm	540: 17,100 fpm; 1000: 17,300 fpm
Dishpan	3/16" Round, Dish Shaped	
Driveline	3-Point & Semi-Mount: Cat. 4 Pull-Type: Cat. 4 Equal Angle or CV	
Driveline Protection	Slip Clutch and Impact Absorbing Cross Shafts to Outer Gearboxes	
Tailwheels	3-Point: 15" or 21" Laminated Pull-Type: 21" Laminated, 24.5" Foam Filled, or 29" Aircraft Tires Semi-Mount: 15" or 21" Laminated	
Colors		



Performance Matched
to **Kubota**
Tractors

TERRAINKING™

Engineering Practical Solutions™

KSB6™

sold exclusively
by selected
Kubota dealers

Manufactured by Terrain King - A reputation you can trust!



Kubota



M60 SERIES



MEET THE M60 SERIES

**CAPABLE.
FUNCTIONAL.
ADAPTABLE.**

The powerful M60 series boasts three separate models consisting of the M5660, M6060, and M7060. Each having been designed with your needs in mind. The M60 Series tractors offer three horsepower ranges at 58.7, 66.4, and 72.1. This lineup provides you with the adaptability to tackle the toughest of tasks. With countless available attachments, the M60 Series is equipped to tackle any challenge.

*SAE J1995 Gross Engine Power



KUBOTA BUILT DIESEL ENGINE

The M60 Series is equipped with the Kubota-built engine and Common-Rail System (CRS) with electronic controlled fuel ejection that continue to be known for its reliability and power. Features include:

LOW NOISE AND LOW VIBRATION

Proven performance minus the unnecessary noise and vibration. Engine components have been engineered with the operator in mind, resulting in an enhanced end user experience.

KUBOTA DIESEL ENGINES

Kubota has been building rugged and durable engines for over 100 years. The M60 Series diesel engines are designed not only to maximize performance, but also keep you operating.

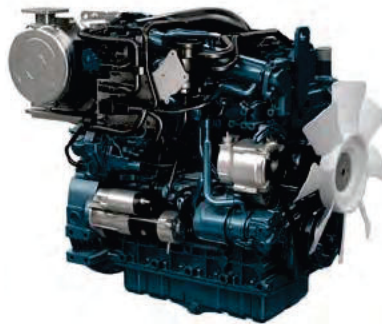

HORSEPOWER RANGES

M5660SUH	58.7 Engine HP / 50 PTO
M5660SUHD	58.7 Engine HP / 50 PTO
M6060HFC	66.4 Engine HP / 56 PTO
M6060HD	66.4 Engine HP / 56 PTO
M6060HDC	66.4 Engine HP / 56 PTO
M7060HFC	72.1 Engine HP / 62 PTO
M7060HD	72.1 Engine HP / 62 PTO
M7060HDC	72.1 Engine HP / 62 PTO
M7060HD12	72.1 Engine HP / 60 PTO
M7060HDC12	72.1 Engine HP / 60 PTO

*SAE J1995 Gross Engine Power

TRAVELING SPEED FOR M7060 F8/R8 MODELS WITH 16.9-30 REAR TIRES @ RATED ENGINE RPM

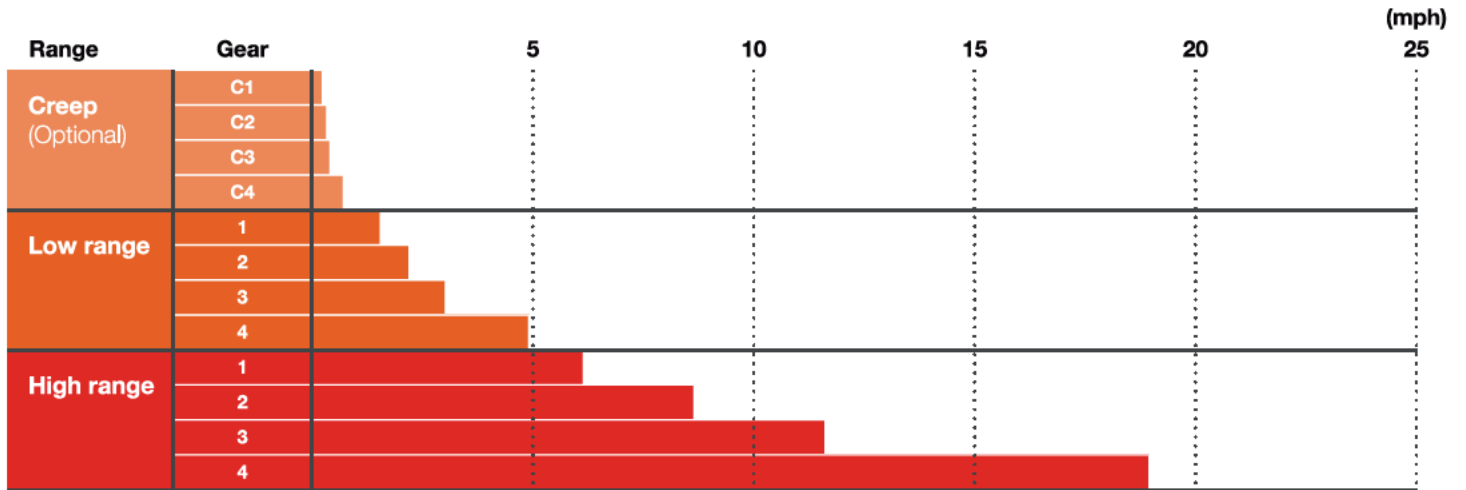

TRAVELING SPEED FOR M7060 F12/R12 MODELS WITH 16.9-30 REAR TIRES @ RATED ENGINE RPM*

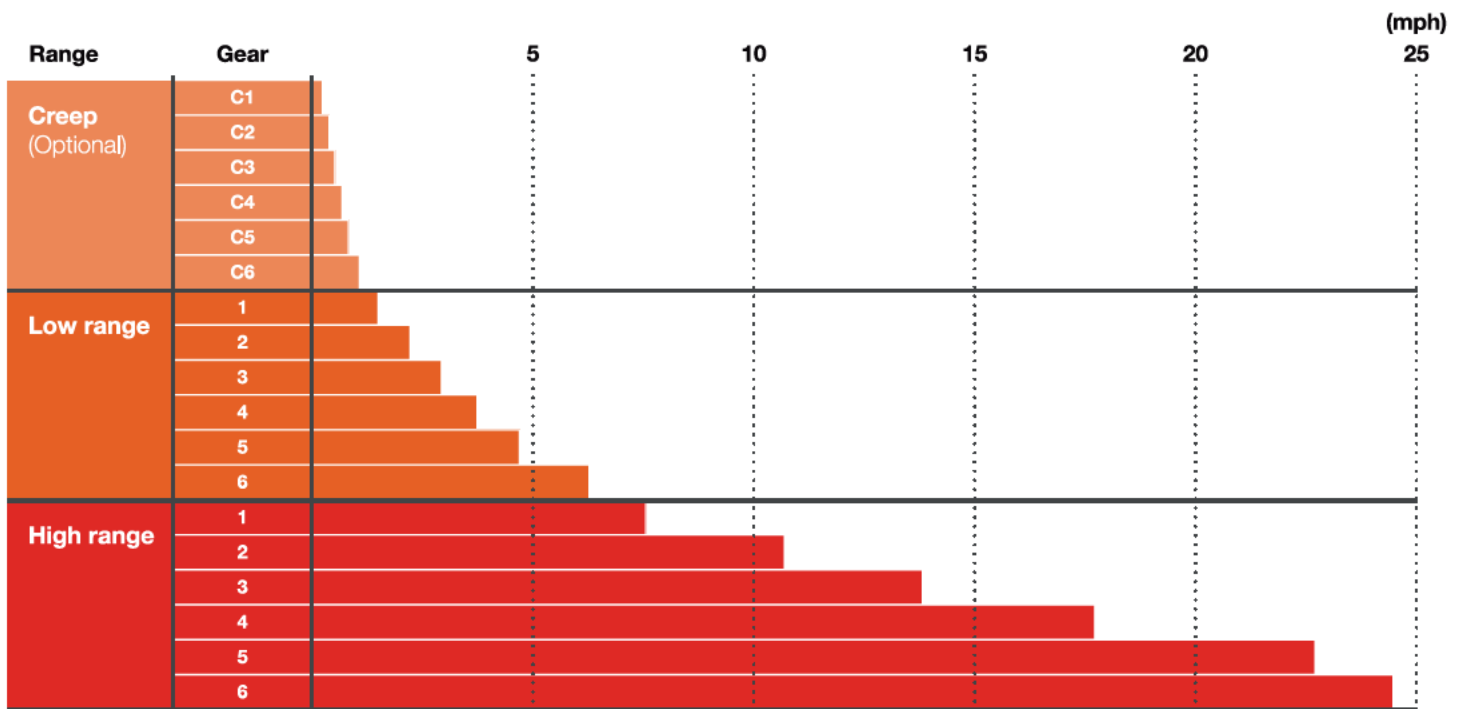

*When H6 gear is selected, over drive function limits the maximum engine revolutions at 1960 rpm for better fuel economy



ADAPTABLE

F8/R8 TRANSMISSION (STANDARD ON M5660SU/SUHD AND M6060HFC/HD/HDC MODELS)

The synchronized four speeds of the main shift and high/low ranges give 8 Forward and 8 Reverse gears.

F12/R12 TRANSMISSION (FACTORY OPTION ON M7060HD/HDC MODELS)

For customers needing more working speed options, the M7060 can be equipped with a F12 / R12 transmission. This transmission features six speeds on the main shift and a high/low range giving it a total of 12 forward and 12 reverse speeds.

HYDRAULIC SHUTTLE

The hydraulic shuttle for the M60 Series makes shifting between forward and reverse smooth and effortless. It increases operator efficiency by allowing you to shift between forward and reverse without the need for a clutch.

TRANSMISSION PARKING LOCK (F12/R12 MODELS ONLY)

The parking lock is a design feature that easily allows the operator to securely place the machine in park. This design allows the operator peace of mind by visibly being able to verify that their tractor parking lock is securely engaged.

OVER DRIVE (F12/R12 MODELS ONLY)*

For road transport applications, when the highest gear (H6 gear) is selected, the over drive function limits the maximum engine revolutions to 1960 RPM for better fuel economy.

3-POINT HITCH*

External hydraulic cylinders improve the lifting power and offer easier maintenance. The rear lift capacity on the M60 Series is 3307lbs, giving you a powerful lift capacity for a wide variety of implements and applications.

TELESCOPIC LOWER LINK ENDS

Kubota's telescopic lower link ends and adjustable lift rods, standard on the M60 Series, ensure quick and simple attachment and adjustment of implements.

BEVEL-GEAR FRONT AXLE

The bevel-gear front axle provides the M60 Series with greater all-around maneuverability. It allows a tighter turning radius which makes jobs easier in tight spaces. Limited slip differential offers increased stability and traction on challenging ground conditions.

*Measured with 16,9-30 size tires.
*3307 lbs 24in behind the lift point.
See owner's manual for details.



ULTRA GRAND CAB

The Ultra Grand Cab is a stylish and spacious cab equipped with both heat and air conditioning, a curved upper windshield, and a comfortable seat to enhance the overall operator experience. Fully enclosed and pressurized cab will assist in preventing dust from entering the operator station, allowing a more dust free work environment. Full length doors provide easier access, while the flat floor and spacious cab provide more head and leg room.

HEATED REAR GLASS

With optional heated rear glass, the operator never has to worry about leaving the seat to defrost their rear window.

HEATER/AIR CONDITIONER

The overall air circulation in the cab has been enhanced by placing vents in optimal locations to give you premium climate control no matter what time of year.

EASY-STEP TILT STEERING WHEEL*

The steering wheel delivers an extra-wide tilt angle for maximum comfort. Just step on the adjustment pedal, tilt the steering wheel and lock for the most comfortable operating position. Step on the pedal again to unlock the wheel for easy tractor mounting and dismounting.

*M6060 and M7060 only.



ROPS OPERATOR STATION

The M60 Series operator station helps to keep you working efficiently and with less fatigue. The high-back bucket seat features lumbar support to help you work efficiently and comfortably even when the work day is long. All levers, including the main shift lever and hydraulic shuttle lever are located within easy reach from a sitting position. An easy-to-operate joystick gives you complete control over the loader's movement and speed.

FUNCTIONAL PLATFORM

The M60 Series is designed with better ergonomics in mind, providing the operator with an overall more comfortable experience. Every control has been optimally placed creating a simplified layout for the operator.

OPTIONAL AIR RIDE SEAT

Specifically designed to absorb shock and reduce operator fatigue, the optional air ride seat provides extra comfort for extended seat time. (Cab models only)

CAB HEADROOM

The M60 Series cab headroom height increases overall visibility when doing loader work and also provides the operator with extra space when entering or exiting the cab.



FUNCTIONAL

HYDRAULICS*

The hydraulics on the M60 Series are powerful and fast-acting. External hydraulic cylinders improve lifting power and ensure easier maintenance, while large pump capacities shortens front-loader cycle times, enhancing productivity and performance.

REAR REMOTE VALVES

The M60 Series comes with one hydraulic rear remote valve (SCD). This series can be fitted with up to three rear remote valves or one valve can be replaced with a flow control valve if desired.

HYDRAULIC INDEPENDENT PTO*

Quick engagement of PTO through electric switch for simple engage and disengagement while operating. Conveniently located, "push and turn" starts and one push stops the PTO. This means mowing and operating hay equipment are all made more efficient. The PTO brake engages when the clutch is shut off and securely holds the PTO shaft.

FUEL SAVING ECONOMY PTO**

F12/R12 models offer standard 540/540E PTO. For economy PTO operation, change the lever to the 540E position. This allows the engine to run at a lower RPM, reducing fuel consumption and eliminating unnecessary noise.

*M6060 and M7060 only.

**Optional for F8/R8 models.



**KEEP PRODUCTIVE AT YOUR FARM BY USING
CONSTANT RPM MANAGEMENT**

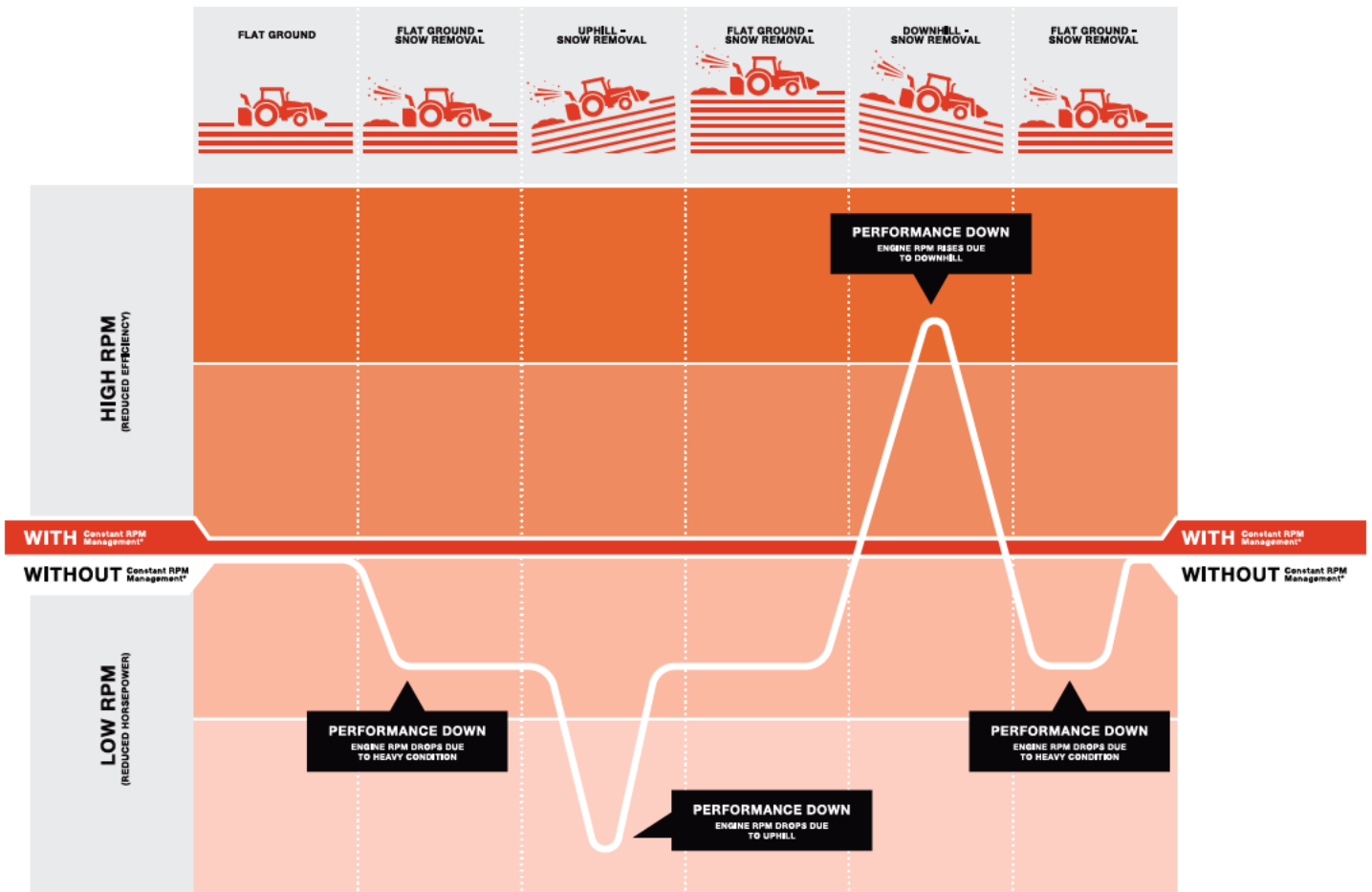



CAPABLE

CONSTANT RPM MANAGEMENT

The M6060/M7060 engine features an electronic control of engine RPM. Activating the system keeps engine revolution nearly constant with a push of the switch, preventing a reduction in PTO speed and enabling stable operation. It makes working with PTO-driven implements much more efficient.

WET DISC BRAKES

The wet disc is going to keep your brakes cooler, allowing you to work harder and more efficiently while performing the toughest of tasks.

MULTIPLE WET DISC CLUTCH

The multi-plate wet disc clutch provides durability and a long operating life.

LIMITED SLIP DIFFERENTIAL

Limited Slip Differential on the front helps you maintain a stable travel speed should the drive wheel on either side of the tractor slip. Limited slip differential is standard on the M7060, and helps maintain a steady travel speed should the front wheel on either side of the tractor begin to slip.

EASY TO SHIFT 4WD ENGAGEMENT

The F8/R8 transmissions have mechanical on the go 4WD engagement for quick and easy operations.

The premium F12/R12 transmission 4WD switch is conveniently located on the control panel so the operator can engage 4WD with a simple press of a switch. The 4WD indicator located on the dash will illuminate to let you know when the 4WD has been engaged.



PERFORMANCE MATCHED KUBOTA-BUILT FRONT LOADER

POWERFUL DESIGN

The M60 Series front loaders provides enough lifting power to tackle the toughest of tasks. This unique loader has been fully integrated into the tractor design resulting in a curved boom to match the tractor hood. This creates a much sleeker look while also providing you with better visibility.

DUAL FUNCTION LOADER VALVE

The M60 Series front loader valve makes operations more intuitive and flexible, by allowing the operator to simultaneously operate the loader hydraulics, enabling them to both raise or lower the loader arms while curling or dumping the bucket to maximize productivity

LIFTING POWER AND HEIGHT

A unique feature of the Kubota designed and built M60 Series front loaders are the power and height lift cylinder positions. The two separate lift cylinder fulcrum points (power position and height position) gives you the option to increase the front loader lifting power or height based on your needs. When maximum lift height is required, the height position provides an additional 15 inches of reach. When working with heavy loads the power position can deliver approximately 10% more lift capacity.



4-BAR LINKAGE

Thanks to the 4-bar bucket linkage, the rollback and dumping angle has been maximized for quicker scooping and dumping.

2-LEVER QUICK COUPLER

The 2-lever quick coupler makes attaching and detaching front mounted implements quick and easy.

PROTECTED CYLINDER TUBES

To better protect the loader hydraulics, the hydraulic tubes are neatly tucked inside the loader boom.

QUICK-MOUNT ATTACH/ DETACH

By following a few quick steps you can attach or detach the loader in minutes. Removing the loader gives you better maneuverability of the tractor in tighter spaces and quick access to key service points.

KUBOTA SHOCKLESS RIDE (KSR) (OPTIONAL)

The KSR is designed to absorb loader shock and reduce operator fatigue. This option is ideal for users that regularly transport heavy loads across uneven terrain. The KSR is equipped with two hydraulic accumulators that store hydraulic fluid to better absorb shock-loading.

3RD FUNCTION VALVE (OPTIONAL)

The optional 3rd function valve transforms your front-end loader into an extension of your hand, giving you precise control over attachments.

SINGLE-LEVER HYDRAULIC QUICK COUPLER (OPTIONAL)

The optional quick coupler allows the operator the ability to attach all four hoses at once. This makes attaching and detaching quick and easy.



LOADER SPECIFICATIONS

MODEL	LA1154				
Matching Tractor	M5660SU		M6060 / M7060		
Loader Model	LA1154SU		LA1154A		
Boom Cylinder Fulcrum	Height Position	Power Position	Height Position	Power Position	
Maximum Lift Height (Pivot Pin)	<i>in. (mm)</i>	130.9 (3326)	115.7 (2938)	132.7 (3370)	117.2 (2977)
Clearance w/Attachment Dump	<i>degrees</i>	99.9 (2537)	84 (2133)	101.5 (2577)	85.5 (2172)
Reach @ Maximum Height	<i>in. (mm)</i>	19.1 (485)	38.4 (976)	18 (458)	35.9 (911)
Maximum Dump Angle	<i>degrees</i>	43	60	43	60
Reach w/Attachment on Ground	<i>in. (mm)</i>	78.1 (1984)		76.7 (1947)	
Maximum Rollback Angle	<i>degrees</i>	45		43	
Digging Depth (When Bucket is Level)	<i>in. (mm)</i>	6.8 (173)	5.9 (150)	5.3 (134)	4.4 (111)
Overall Height in Carry Position	<i>in. (mm)</i>	59.6 (1513)		61.9 (1573)	
Lift Capacity (Pivot Pin) Max. Height	<i>lbs. (kg)</i>	2469 (1120)	2928 (1328)	2469 (1120)	2928 (1328)
Lift Capacity (Pivot Pin @ 1.5m)	<i>lbs. (kg)</i>	3210 (1456)	3686 (1672)	3210 (1456)	3686 (1672)
Material Bucket Width / Capacity (Heaped)	<i>in. / cu.ft. (m)</i>	Round Back Bucket = 72" / 19.4 (.55) Light Material Bucket = 84" / 27.9 (.79)			
Raising Time to Full Height w/out Load	<i>Second</i>	4.5			
Lowering Time w/out Load (Powerdown)	<i>Second</i>	3.3			
Attachment Rollback Time	<i>Second</i>	2.8			
Attachment Dumping Time	<i>Second</i>	2.5			

SPECIFICATIONS

MODEL	M5660		M6060		M7060		
	2WD	4WD	2WD	4WD	2WD	4WD	
ROPS / CAB	SUH	SUHD	HFC	HD / HDC	HFC	HD / HDC	HD12 / HDC12
ENGINE	V2403-CR-TE4		V3307-CR-TE4				
Type (Make: Kubota)	4 Cylinder In-line, Common Rail System, Direct Inject.						
No. of Cylinders / Aspiration	4 / Turbocharged						
Engine Gross Power*	<i>HP (kW)</i>	58.7 (43.7)	66.4 (49.5)		72.1 (53.7)		
PTO Power	<i>HP (kW)</i>	50 (37.3)	56 (41.7)		62 (46.2)	60 (44.7)	
Total Displacement	<i>cu.in. (cc)</i>	148.5 (2434)	203 (3331)				
Rated Engine RPM	ROPS/CAB <i>RPM</i>	2600 RPM		2400			
Fuel Tank Capacity	ROPS/CAB <i>gal. (l)</i>	17.7 (67)	18.5 (70) / 23.8 (90)				
Alternator	ROPS/CAB	45 AMP	45 AMP / 60 AMP (100 Amp: OPT)				
TRANSMISSION							
No. of Speeds	F8 / R8					F12 / R12	
Main Gear Shift	Fully Synchronized (4 speed)					Fully Synchronized (6 speed)	
Shuttle Shift	Hydraulic-Shuttle						
Main Clutch Type	Multiple Wet Disc						
Brake Type	Mechanical Wet Disc					Hydraulic Wet Disc	
Differential Lock (Front / Rear)	Rear Standard (Mechanical)	-	- / Mechanical	-	Limited Slip Differential / Mechanical		
4WD Clutch Type	-	-	Mechanical on-the-go	-	Mechanical on-the-go	Electro-Hydraulic on-the-go	
PTO							
Type	Live-independent, Hydraulic PTO with PTO Brake, Multiple Wet Clutch		Live-independent PTO, Electro-hydraulic Clutch with Brake				
Speed	<i>RPM</i>	540 (540 / 540E: OPT)					540 / 540E
HYDRAULICS							
Pump Capacity (3-Point Hitch)	ROPS/CAB <i>gpm (l/min.)</i>	10.6 (40.2)	11.0 (41.6)			16.2 (61.5)	
3-Point Hitch	Telescopic Lower Link Ends, Telescopic Stabilizers						
Category	I / II						
Control System	Position		Position, Draft (Top Link Sensing) & Mixed Control				
Lift Capacity at 24 in. Behind Lift Point	<i>lbs. (kg)</i>	3307 (1500)					
Cylinder Type	Internal or "Single		Two External Cylinders				
No. of Standard Remote Valves	1, SCD (2nd, 3rd & Flow Control Valve Optional)						

SPECIFICATIONS

MODEL	M5560		M6060		M7060			
	2WD	4WD	2WD	4WD	2WD	4WD		
OTHER FEATURES								
4WD System	-	Bevel Gear Type	-	Bevel Gear Type	-	Bevel Gear Type		
Steering	Hydrostatic Power Steering							
Tilt Steering	N/A		Standard					
Hood Type / Pedal Type	Full Open, Slanted, Steel / Hanging							
Deck Type (ISO-mounted w/Rubber Mat)	Semi-flat		Semi-flat on ROPS Models, Full-flat on CAB Models					
Panel Type	Analog w/ LCD		Electronic					
Fender Shape	Wide, Round							
STANDARD TIRE SIZE								
Front	9.5L-15	9.5-22	9.5L-15	9.5-24	9.5-24	9.5-24		
Rear	14.9-28	14.9-28	16.9-28 / 14.9-28		16.9-30			
DIMENSIONS & WEIGHT								
Overall Length	ROPS Models	<i>in.</i> (<i>mm</i>)	138.7 (3525)	136 (3455)	-	138.0 (3505)	-	138.0 (3505)
	CAB Models	<i>in.</i> (<i>mm</i>)			142.7 (3625)	138.0 (3505)	142.7 (3625)	138.0 (3505)
Overall Height	Top of ROPS	<i>in.</i> (<i>mm</i>)	95.3 (2420)		-	96.9 (2460)	-	97.2 (2470)
	Top of CAB	<i>in.</i> (<i>mm</i>)			100.6 (2555)		101.0 (2565)	
Overall Width (Minimum)		<i>in.</i> (<i>mm</i>)	73.0 (1860)					
Wheelbase	ROPS Models	<i>in.</i> (<i>mm</i>)	82 (2085)	82 (2085) 80.7 (2050)	-	83.1 (2110)	-	83.1 (2110)
	CAB Models	<i>in.</i> (<i>mm</i>)			84.4 (2145)	83.1 (2110)	84.4 (2145)	83.1 (2110)
Crop Clearance (Front Axle)		<i>in.</i> (<i>mm</i>)	16.9 (430)	17.7 (450)	18.1 (460)			
Tread Width	Front	<i>in.</i> (<i>mm</i>)	55.9, 71.7 (1420, 1820)	51.2, 55.1 (1300,1400)	55.9-71.7 (1420-1820)	55.9, 59.8 (1420, 1520)	55.9-71.7 (1420-1820)	55.9, 59.8 (1420, 1520)
	Rear	<i>in.</i> (<i>mm</i>)	52.0, 67.7 (1320, 1720)		55.9-67.7 (1420-1720)			
Turning Radius (w/o Brake)		<i>ft.</i> (<i>m</i>)	11.1 (3.4)	12.8 (3.9)	10.8 (3.3)	11.8 (3.6)	10.8 (3.3)	11.8 (3.6)
Tractor Weight	ROPS Models	<i>lbs.</i> (<i>kg</i>)	4189 (1900)	4387 (1990)	-	5005 (2270)	-	5027 (2280)
	CAB Models	<i>lbs.</i> (<i>kg</i>)			5226 (2370)	5358 (2430)	5248 (2380)	5380 (2440)

*SAE J1995
*1) w/ Standard valves.



Kubota Tractor Corporation reserves the right to change the stated specifications without notice. This brochure is for descriptive purposes only and reasonable efforts were used to set forth the contained information; some items shown may be optional and some products shown may not be available at all dealerships. Kubota disclaims all representations and warranties, express or implied, or any liability from the use of this brochure. For complete warranty, safety and product information, consult your local Kubota dealer and the operator's manual. Power (HP/KW) and other specifications are based on various standards or recommended practices. For your safety, Kubota strongly recommends the use of a Rollover Protective Structure (ROPS) and seat belt in almost all applications. This brochure is intended for the United States and US territories only. For information regarding Kubota products or services outside these areas, see Kubota Corporation's global web site. Kubota does not provide parts, warranty or service for any Product which is re-sold or retailed in any country other than the country for which the Product(s) were designed or manufactured.

VERSATILITY TO DO MORE

Learn more about Kubota's
full implement range by
visiting [kubotausa.com/products/
tractors/utility/m60](https://www.kubotausa.com/products/tractors/utility/m60)



- 1** BAT-WING
ROTARY CUTTER
- 2** POST HOLE
DIGGER
- 3** BOX BLADE
- 4** ROTARY CUTTER
- 5** BALE SPEAR
- 6** COMBINATION
BUCKET
- 7** TEDDER

The Kubota M60 Series comes with a wide range of Kubota hay tools and Land Pride's performance-matched implements and attachments. They are designed to work seamlessly with Kubota equipment to take on your toughest farming, municipality, and property maintenance tasks, giving you the power to haul, drag, grade, cut, and cultivate. This capable series makes the most complex task manageable on your farm, ranch, or worksite.



KUBOTA TRACTOR CORPORATION

1000 Kubota Drive, Grapevine, TX 76051 | www.kubotausa.com



© 2023 Kubota Tractor Corporation | Part #: 329301

For Earth, For Life
Kubota



GENERAL SPECS

- 72" Cutting Swath
- Cutting Capacity: 1/2" Grass & Light Brush
- Total Weight: 500 lbs.
- Ability to Cut 90° Up to 75° Down

COMPATIBLE TRACTORS

- KUBOTA M8560 series
- KUBOTA M9960 series
- KUBOTA M108S series



CUTTER BAR

- Proven blade design features 25 Serrated Knife Sections, Coated for Corrosion Resistance
- Built in Heavy Duty Rock Guards
- Full-floating cutterbar follows contour of ground



SKID SHOE

- 3/16" High Strength Alloy Steel
- Fully Replaceable

SAFETY BREAKAWAY

- Hydraulic Breakaway System: Returns to normal position by pushing the operator control lever
- Breakaway Swing: 90° from horizontal position



MOUNTING FRAME

- Side Mounted Ahead of the Right Rear Wheel
- Rigid subframe spans from the front bolster to the rear axle



TRANSPORT

- Mechanical Safety Transport Lock
Secures the Lift Function in Transport



MOWER LIFT ASSEMBLY

- Can Raise 12" Above Grade* * Depending on Tractor Applications
- Can Lower 2" Below Grade*
- Tilt Adjustment: 20° Total Movement



HYDRAULIC CONTROL VALVE

- 2 Spool, Open Center Type
- Operator Station features dual axis lever controls, master cutoff switch, & blade reverser switch to clear knife jams



HYDRAULIC POWER

- Front Mounted Tandem Style Pump
- Cutter Bar: Crankshaft / flywheel system with a Gerotor type hydraulic motor
- Built-in knife obstruction relief valve



HYDRAULIC RESERVOIR

- 4.5 Gallon Capacity
- Return filter assembly with integrated filler cap, breather element, & visual filter condition gauge
- Cleanout Access & Magnetic Drain Plug
- Combination fluid level & temperature sight gauge

the CuttingEdge Safetyprogram

T.M.O.S.T. (Tractor Mower Operator Safety Training) 8 Hour Safety Training Course

- Includes both classroom & hands-on training with your actual equipment
- Led by an instructor with 28+ years of safety training experience, who is an OSHA Authorized, National Association of Safety Professionals (NASP) certified Safety Training / Planning Specialist and Equipment Authorized Trainer with an unusual methodology of making safety training fun and interesting
- Based upon the strict guidelines of the American Equipment Manufacturers Assn. (AEM)
- Covers ANY and ALL industrial mower and agricultural tractor manufacturers including but not limited to: Terrain King, Alamo Industrial, Tiger, M&W, Rhino, Bush Hog, John Deere, New Holland, Woods, Land Pride And Many Others
- Conducted at your location directly with your employees OR with your safety trainer(s)

What are the benefits to me and my organization?

- Pre and post-course testing for all participants
- Effective training can significantly decrease mower-related incidents
- Potentially affects your bottom line
- Supports your commitment to providing a safe, hazard free work environment for your employees

Additional Courses Offered:

- TMOST 2.5 Hour Safety Training
- Workplace Safety & Personal Responsibility
- Operator & Technician Service Tips

For More Information, Please Contact:

Jim Green – Trainer
jwgreen@alamo-group.com
830-305-4294 cell

www.terrainking.com/safety



**OEM PERFORMANCE
PARTS**
TERRAIN KING™

Terrain King™ Performance OEM Parts offer the safety, durability and warranty protection you expect.

- Tested to Meet All SAE & ASAE Safety Standards
- Stocking Programs Available
- High Wear Kits Available

We have a team of knowledgeable, experienced representatives ready to help you with your selection and to assist in finding the parts you need.

If you have any questions, please contact us at:
oenparts@terrainking.com

RCF27 SERIES ROTARY CUTTERS

SINGLE SPINDLE: 35-130 HP | Cat. 1, 2 & 3



	RCF2760	RCF2772	RCF2784
Horsepower	35-130 HP		60-130 HP
Hitch	Cat. 1 & 2		Cat. 2 & 3, Pull-Type
Working Width	60" (152)	72 (183)	84 (213)
Overall Width	67"	79"	89"
Overall Length	109"	121-3/4"	Single 132.5", Dual 130"
Weight - lb (kg)	955 (433)	1,072 (486)	1,354 (614), Pull-Type: 1632 (740)
Cutting Height	1-1/2" - 12"		
Cutting Capacity	3" Diameter		
Deck	All Welded, Smooth Top		
Deck Thickness	10 Gauge		
Deck Height	11-1/4"	10-1/8"	
Side Thickness	1/4"		
Safety Guards	Front: Chain or Rubber, Rear: Chain		
Skids	Replaceable		
Blades	Free Swinging High Suction, 1/2" x 4" - Heat Treated		
Blade Bolt	Keyed with Hardened, Flat Washer & Lock Nut		
Blade Tip Speed	12,384 fpm	14,861 fpm	14,369 fpm
Dishpan	3/16" x 24" Round, Dish Shaped	3/16" x 30-1/2" Round, Dish Shaped	3/16" x 24" x 38" Oval, Dish Shaped
Gearbox Rating[^]	130 HP		
Gearbox	540 RPM 1-3/8" - 6 Spline		
Gearbox Output Shaft	2"		
Driveline	Cat. 4 with 4 Plate Slip Clutch		
Tailwheel(s)	15" Laminated, w/Cast Iron Hub, Tapered Roller Bearings		
Colors			

Roundback with a smooth top.

The RCF27 Series Rotary Cutter is a smooth top version of our RCR26 Series, offering the same great cut and is ideal for grass, weeds, crops, brush, and small trees up to 3 inches in diameter. These units come equipped standard with a 3/16" thick heavy-duty stump jumper and replaceable bolt-on skid shoes.



- Smooth top design
- All welded deck
- Clevis style lower hitch
- Floating top hitch
- 84" Pull-type model available
- Dual wheels optional on 3-Point 84" model, Standard on Pull-Type



Replaceable bolt-on skid shoes provide sidewall reinforcement and protection to the bottom of sidewall.



Optional shields are available for the front and rear to protect against flying debris.



The laminated tailwheel is long lasting in rough conditions and 1-1/2" heavy-duty spindle protects the assembly.

[^]See dealer for complete warranty information. [^]Based on field performance.



**Kubota
M7060HDC**

**A: Overall
Length, 138"**

**D: Wheelbase,
83.1"**

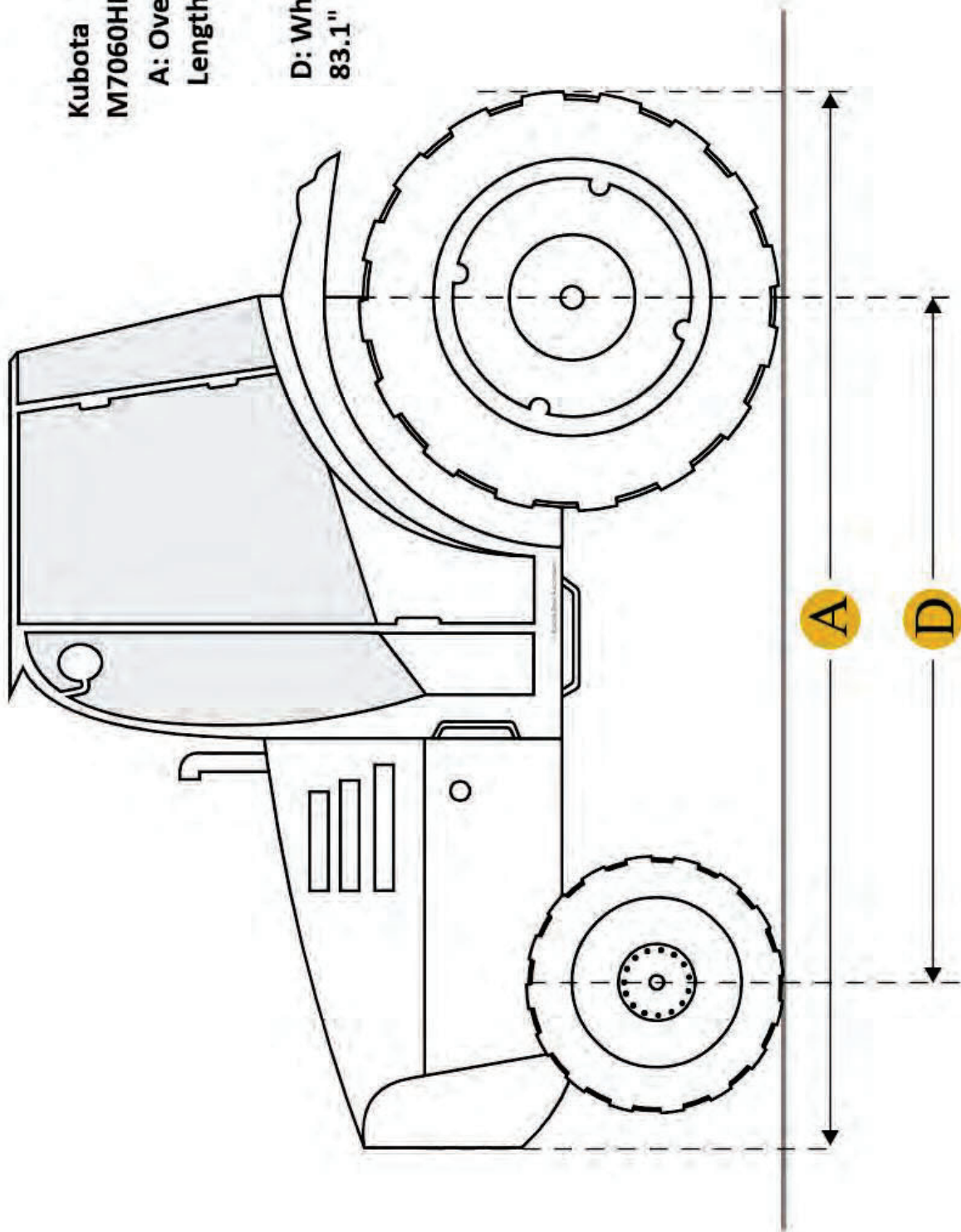

**Kubota
M7060HDC**

**B: Overall Tread
width,
adjustable
55.9-67.7"
Overall Width,
73"**

**C: Overall Height
to top of cab
101"**

**E: Ground
Clearance, 18.1"**

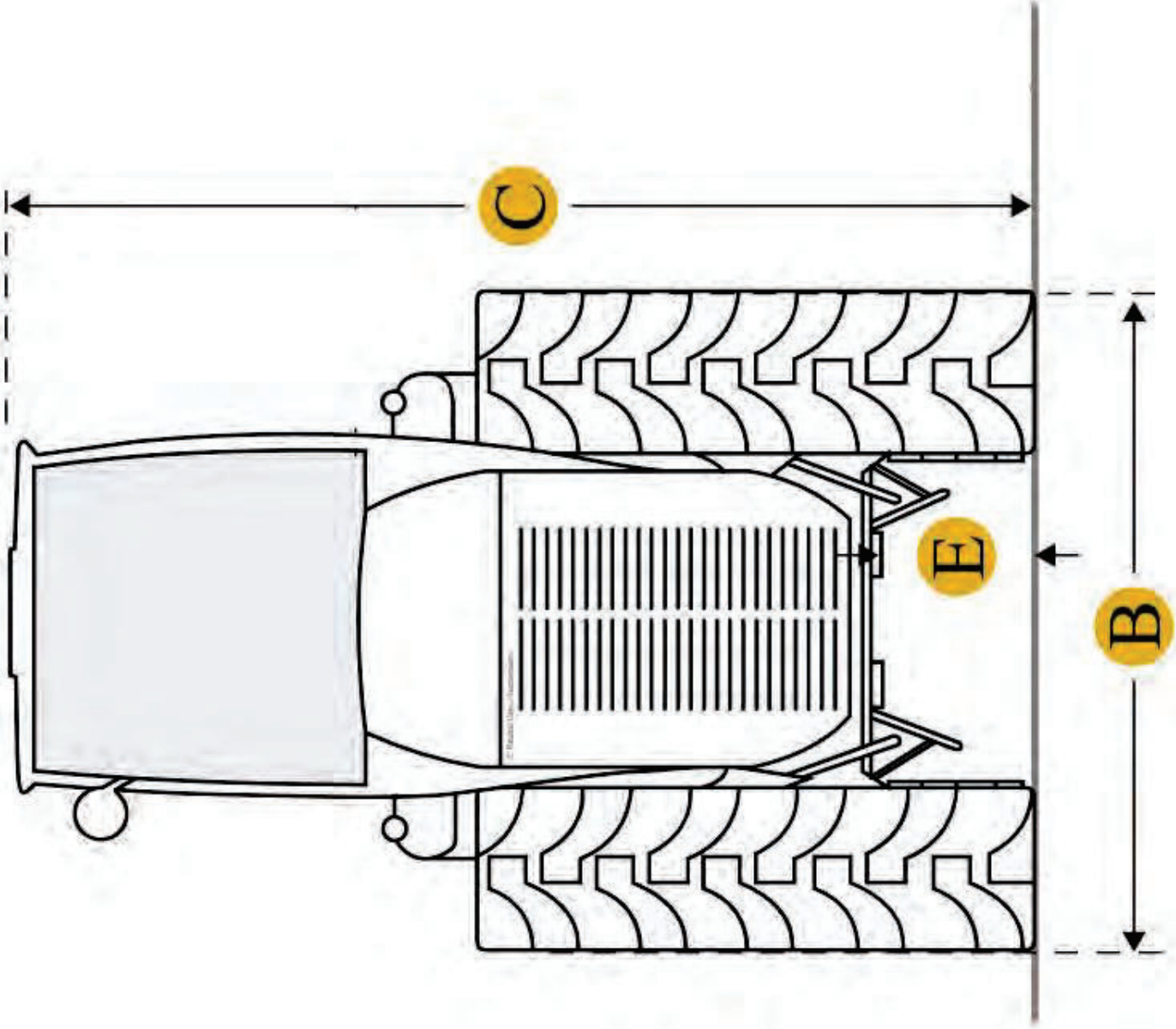

EXHIBIT XIII

Economic Disclosure Statement Forms, *including Contract and EDS Signature Pages*

**COOK COUNTY
ECONOMIC DISCLOSURE STATEMENT
AND EXECUTION DOCUMENT
INDEX**

Section	Description	Pages
1	Instructions for Completion of EDS	EDS i - ii
2	Certifications	EDS 1- 2
3	Economic and Other Disclosures, Affidavit of Child Support Obligations, Disclosure of Ownership Interest and Familial Relationship Disclosure Form	EDS 3 - 12
4	Cook County Affidavit for Wage Theft Ordinance	EDS 13-14
5	Contract and EDS Execution Page	EDS 15
6	Cook County Signature Page	EDS 16

SECTION 1
INSTRUCTIONS FOR COMPLETION OF
ECONOMIC DISCLOSURE STATEMENT AND EXECUTION DOCUMENT

This Economic Disclosure Statement and Execution Document ("EDS") is to be completed and executed by every Bidder on a County contract, every Proposer responding to a Request for Proposals, and every Respondent responding to a Request for Qualifications, and others as required by the Chief Procurement Officer. The execution of the EDS shall serve as the execution of a contract awarded by the County. The Chief Procurement Officer reserves the right to request that the Bidder or Proposer, or Respondent provide an updated EDS on an annual basis.

Definitions. Terms used in this EDS and not otherwise defined herein shall have the meanings given to such terms in the Instructions to Bidders, General Conditions, Request for Proposals, Request for Qualifications, as applicable.

Affiliate means a person that directly or indirectly through one or more intermediaries, Controls is Controlled by, or is under common Control with the Person specified.

Applicant means a person who executes this EDS.

Bidder means any person who submits a Bid.

Code means the Code of Ordinances, Cook County, Illinois available on municode.com.

Contract shall include any written document to make Procurements by or on behalf of Cook County.

Contractor or *Contracting Party* means a person that enters into a Contract with the County.

Control means the unfettered authority to directly or indirectly manage governance, administration, work, and all other aspects of a business.

EDS means this complete Economic Disclosure Statement and Execution Document, including all sections listed in the Index and any attachments.

Joint Venture means an association of two or more Persons proposing to perform a for-profit business enterprise. Joint Ventures must have an agreement in writing specifying the terms and conditions of the relationship between the partners and their relationship and respective responsibility for the Contract

Lobby or *lobbying* means to, for compensation, attempt to influence a County official or County employee with respect to any County matter.

Lobbyist means any person who lobbies.

Person or *Persons* means any individual, corporation, partnership, Joint Venture, trust, association, Limited Liability Company, sole proprietorship or other legal entity.

Prohibited Acts means any of the actions or occurrences which form the basis for disqualification under the Code, or under the Certifications hereinafter set forth.

Proposal means a response to an RFP.

Proposer means a person submitting a Proposal.

Response means response to an RFQ.

Respondent means a person responding to an RFQ.

RFP means a Request for Proposals issued pursuant to this Procurement Code.

RFQ means a Request for Qualifications issued to obtain the qualifications of interested parties.

**INSTRUCTIONS FOR COMPLETION OF
ECONOMIC DISCLOSURE STATEMENT AND EXECUTION DOCUMENT**

Section 1: Instructions. Section 1 sets forth the instructions for completing and executing this EDS.

Section 2: Certifications. Section 2 sets forth certifications that are required for contracting parties under the Code and other applicable laws. Execution of this EDS constitutes a warranty that all the statements and certifications contained, and all the facts stated, in the Certifications are true, correct and complete as of the date of execution.

Section 3: Economic and Other Disclosures Statement. Section 3 is the County's required Economic and Other Disclosures Statement form. Execution of this EDS constitutes a warranty that all the information provided in the EDS is true, correct and complete as of the date of execution, and binds the Applicant to the warranties, representations, agreements and acknowledgements contained therein.

Required Updates. The Applicant is required to keep all information provided in this EDS current and accurate. In the event of any change in the information provided, including but not limited to any change which would render inaccurate or incomplete any certification or statement made in this EDS, the Applicant shall supplement this EDS up to the time the County takes action, by filing an amended EDS or such other documentation as is required.

Additional Information. The County's Governmental Ethics and Campaign Financing Ordinances impose certain duties and obligations on persons or entities seeking County contracts, work, business, or transactions, and the Applicant is expected to comply fully with these ordinances. For further information please contact the Director of Ethics at (312) 603-4304 (69 W. Washington St. Suite 3040, Chicago, IL 60602) or visit the web-site at cookcountyil.gov/ethics-board-of.

Authorized Signers of Contract and EDS Execution Page. If the Applicant is a corporation, the President and Secretary must execute the EDS. In the event that this EDS is executed by someone other than the President, attach hereto a certified copy of that section of the Corporate By-Laws or other authorization by the Corporation, satisfactory to the County that permits the person to execute EDS for said corporation. If the corporation is not registered in the State of Illinois, a copy of the Certificate of Good Standing from the state of incorporation must be submitted with this Signature Page.

If the Applicant is a partnership or joint venture, all partners or joint venturers must execute the EDS, unless one partner or joint venture has been authorized to sign for the partnership or joint venture, in which case, the partnership agreement, resolution or evidence of such authority satisfactory to the Office of the Chief Procurement Officer must be submitted with this Signature Page.

If the Applicant is a member-managed LLC all members must execute the EDS, unless otherwise provided in the operating agreement, resolution or other corporate documents. If the Applicant is a manager-managed LLC, the manager(s) must execute the EDS. The Applicant must attach either a certified copy of the operating agreement, resolution or other authorization, satisfactory to the County, demonstrating such person has the authority to execute the EDS on behalf of the LLC. If the LLC is not registered in the State of Illinois, a copy of a current Certificate of Good Standing from the state of incorporation must be submitted with this Signature Page.

If the Applicant is a Sole Proprietorship, the sole proprietor must execute the EDS.

A "Partnership" "Joint Venture" or "Sole Proprietorship" operating under an Assumed Name must be registered with the Illinois county in which it is located, as provided in 805 ILCS 405 (2012), and documentation evidencing registration must be submitted with the EDS.

Effective October 1, 2016 all foreign corporations and LLCs must be registered with the Illinois Secretary of State's Office unless a statutory exemption applies to the applicant. Applicants who are exempt from registering must provide a written statement explaining why they are exempt from registering as a foreign entity with the Illinois Secretary of State's Office.

SECTION 2

CERTIFICATIONS

THE FOLLOWING CERTIFICATIONS ARE MADE PURSUANT TO STATE LAW AND THE CODE. THE APPLICANT IS CAUTIONED TO CAREFULLY READ THESE CERTIFICATIONS PRIOR TO SIGNING THE SIGNATURE PAGE. SIGNING THE SIGNATURE PAGE SHALL CONSTITUTE A WARRANTY BY THE APPLICANT THAT ALL THE STATEMENTS, CERTIFICATIONS AND INFORMATION SET FORTH WITHIN THESE CERTIFICATIONS ARE TRUE, COMPLETE AND CORRECT AS OF THE DATE THE SIGNATURE PAGE IS SIGNED. THE APPLICANT IS NOTIFIED THAT IF THE COUNTY LEARNS THAT ANY OF THE FOLLOWING CERTIFICATIONS WERE FALSELY MADE, THAT ANY CONTRACT ENTERED INTO WITH THE APPLICANT SHALL BE SUBJECT TO TERMINATION.

A. PERSONS AND ENTITIES SUBJECT TO DISQUALIFICATION

No person or business entity shall be awarded a contract or sub-contract, for a period of five (5) years from the date of conviction or entry of a plea or admission of guilt, civil or criminal, if that person or business entity:

- 1) Has been convicted of an act committed, within the State of Illinois, of bribery or attempting to bribe an officer or employee of a unit of state, federal or local government or school district in the State of Illinois in that officer's or employee's official capacity;
- 2) Has been convicted by federal, state or local government of an act of bid-rigging or attempting to rig bids as defined in the Sherman Anti-Trust Act and Clayton Act. Act. 15 U.S.C. Section 1 *et seq.*;
- 3) Has been convicted of bid-rigging or attempting to rig bids under the laws of federal, state or local government;
- 4) Has been convicted of an act committed, within the State, of price-fixing or attempting to fix prices as defined by the Sherman Anti-Trust Act and the Clayton Act. 15 U.S.C. Section 1, *et seq.*;
- 5) Has been convicted of price-fixing or attempting to fix prices under the laws the State;
- 6) Has been convicted of defrauding or attempting to defraud any unit of state or local government or school district within the State of Illinois;
- 7) Has made an admission of guilt of such conduct as set forth in subsections (1) through (6) above which admission is a matter of record, whether or not such person or business entity was subject to prosecution for the offense or offenses admitted to; or
- 8) Has entered a plea of *nolo contendere* to charge of bribery, price-fixing, bid-rigging, or fraud, as set forth in sub-paragraphs (1) through (6) above.

In the case of bribery or attempting to bribe, a business entity may not be awarded a contract if an official, agent or employee of such business entity committed the Prohibited Act on behalf of the business entity and pursuant to the direction or authorization of an officer, director or other responsible official of the business entity, and such Prohibited Act occurred within three years prior to the award of the contract. In addition, a business entity shall be disqualified if an owner, partner or shareholder controlling, directly or indirectly, 20% or more of the business entity, or an officer of the business entity has performed any Prohibited Act within five years prior to the award of the Contract.

THE APPLICANT HEREBY CERTIFIES THAT: The Applicant has read the provisions of Section A, Persons and Entities Subject to Disqualification, that the Applicant has not committed any Prohibited Act set forth in Section A, and that award of the Contract to the Applicant would not violate the provisions of such Section or of the Code.

B. BID-RIGGING OR BID ROTATING

THE APPLICANT HEREBY CERTIFIES THAT: In accordance with 720 ILCS 5/33 E-11, neither the Applicant nor any Affiliated Entity is barred from award of this Contract as a result of a conviction for the violation of State laws prohibiting bid-rigging or bid rotating.

C. DRUG FREE WORKPLACE ACT

THE APPLICANT HEREBY CERTIFIES THAT: The Applicant will provide a drug free workplace, as required by (30 ILCS 580/3).

D. DELINQUENCY IN PAYMENT OF TAXES

THE APPLICANT HEREBY CERTIFIES THAT: *The Applicant is not an owner or a party responsible for the payment of any tax or fee administered by Cook County, such as bar award of a contract or subcontract pursuant to the Code, Chapter 34, Section 34-171.*

E. HUMAN RIGHTS ORDINANCE

No person who is a party to a contract with Cook County ("County") shall engage in unlawful discrimination or sexual harassment against any individual in the terms or conditions of employment, credit, public accommodations, housing, or provision of County facilities, services or programs (Code Chapter 42, Section 42-30 *et seq.*).

F. ILLINOIS HUMAN RIGHTS ACT

THE APPLICANT HEREBY CERTIFIES THAT: *It is in compliance with the Illinois Human Rights Act (775 ILCS 5/2-105), and agrees to abide by the requirements of the Act as part of its contractual obligations.*

G. INSPECTOR GENERAL (COOK COUNTY CODE, CHAPTER 34, SECTION 34-174 and Section 34-250)

The Applicant has not willfully failed to cooperate in an investigation by the Cook County Independent Inspector General or to report to the Independent Inspector General any and all information concerning conduct which they know to involve corruption, or other criminal activity, by another county employee or official, which concerns his or her office of employment or County related transaction.

The Applicant has reported directly and without any undue delay any suspected or known fraudulent activity in the County's Procurement process to the Office of the Cook County Inspector General.

H. CAMPAIGN CONTRIBUTIONS (COOK COUNTY CODE, CHAPTER 2, SECTION 2-585)

THE APPLICANT CERTIFIES THAT: It has read and shall comply with the Cook County's Ordinance concerning campaign contributions, which is codified at Chapter 2, Division 2, Subdivision II, Section 585, and can be read in its entirety at www.municode.com.

I. GIFT BAN, (COOK COUNTY CODE, CHAPTER 2, SECTION 2-574)

THE APPLICANT CERTIFIES THAT: It has read and shall comply with the Cook County's Ordinance concerning receiving and soliciting gifts and favors, which is codified at Chapter 2, Division 2, Subdivision II, Section 574, and can be read in its entirety at www.municode.com.

J. LIVING WAGE ORDINANCE PREFERENCE (COOK COUNTY CODE, CHAPTER 34, SECTION 34-160;

Unless expressly waived by the Cook County Board of Commissioners, the Code requires that a living wage must be paid to individuals employed by a Contractor which has a County Contract and by all subcontractors of such Contractor under a County Contract, throughout the duration of such County Contract. The amount of such living wage is annually by the Chief Financial Officer of the County, and shall be posted on the Chief Procurement Officer's website.

The term "Contract" as used in Section 4, I, of this EDS, specifically excludes contracts with the following:

- 1) Not-For Profit Organizations (defined as a corporation having tax exempt status under Section 501(C)(3) of the United State Internal Revenue Code and recognized under the Illinois State not-for -profit law);
- 2) Community Development Block Grants;
- 3) Cook County Works Department;
- 4) Sheriff's Work Alternative Program; and
- 5) Department of Correction inmates.

SECTION 3

REQUIRED DISCLOSURES

1. DISCLOSURE OF LOBBYIST CONTACTS

List all persons that have made lobbying contacts on your behalf with respect to this contract:

Name	Address
NA	

2. LOCAL BUSINESS PREFERENCE STATEMENT (CODE, CHAPTER 34, SECTION 34-230)

Local business means a Person, including a foreign corporation authorized to transact business in Illinois, having a bona fide establishment located within the County at which it is transacting business on the date when a Bid is submitted to the County, and which employs the majority of its regular, full-time work force within the County. A Joint Venture shall constitute a Local Business if one or more Persons that qualify as a "Local Business" hold interests totaling over 50 percent in the Joint Venture, even if the Joint Venture does not, at the time of the Bid submittal, have such a bona fide establishment within the County.

a) Is Applicant a "Local Business" as defined above?

Yes: No:

b) If yes, list business addresses within Cook County:

c) Does Applicant employ the majority of its regular full-time workforce within Cook County?

Yes: No:

3. THE CHILD SUPPORT ENFORCEMENT ORDINANCE (CODE, CHAPTER 34, SECTION 34-172)

Every Applicant for a County Privilege shall be in full compliance with any child support order before such Applicant is entitled to receive or renew a County Privilege. When delinquent child support exists, the County shall not issue or renew any County Privilege, and may revoke any County Privilege.

All Applicants are required to review the Cook County Affidavit of Child Support Obligations attached to this EDS (EDS-5) and complete the Affidavit, based on the instructions in the Affidavit.

4. REAL ESTATE OWNERSHIP DISCLOSURES.

The Applicant must indicate by checking the appropriate provision below and providing all required information that either:

- a) The following is a complete list of all real estate owned by the Applicant in Cook County:

PERMANENT INDEX NUMBER(S): _____

(ATTACH SHEET IF NECESSARY TO LIST ADDITIONAL INDEX NUMBERS)

OR:

- b) The Applicant owns no real estate in Cook County.

5. EXCEPTIONS TO CERTIFICATIONS OR DISCLOSURES.

If the Applicant is unable to certify to any of the Certifications or any other statements contained in this EDS and not explained elsewhere in this EDS, the Applicant must explain below:

If the letters, "NA", the word "None" or "No Response" appears above, or if the space is left blank, it will be conclusively presumed that the Applicant certified to all Certifications and other statements contained in this EDS.

COOK COUNTY DISCLOSURE OF OWNERSHIP INTEREST STATEMENT

The Cook County Code of Ordinances (§2-610 *et seq.*) requires that any Applicant for any County Action must disclose information concerning ownership interests in the Applicant. This Disclosure of Ownership Interest Statement must be completed with all information current as of the date this Statement is signed. Furthermore, this Statement must be kept current, by filing an amended Statement, until such time as the County Board or County Agency shall take action on the application. The information contained in this Statement will be maintained in a database and made available for public viewing. **County reserves the right to request additional information to verify veracity of information contained in this statement.**

If you are asked to list names, but there are no applicable names to list, you must state NONE. An incomplete Statement will be returned and any action regarding this contract will be delayed. A failure to fully comply with the ordinance may result in the action taken by the County Board or County Agency being voided.

"Applicant" means any Entity or person making an application to the County for any County Action.

"County Action" means any action by a County Agency, a County Department, or the County Board regarding an ordinance or ordinance amendment, a County Board approval, or other County agency approval, with respect to contracts, leases, or sale or purchase of real estate.

"Person" "Entity" or "Legal Entity" means a sole proprietorship, corporation, partnership, association, business trust, estate, two or more persons having a joint or common interest, trustee of a land trust, other commercial or legal entity or any beneficiary or beneficiaries thereof.

This Disclosure of Ownership Interest Statement must be submitted by :

1. An Applicant for County Action and
2. A Person that holds stock or a beneficial interest in the Applicant and is listed on the Applicant's Statement (a "Holder") must file a Statement and complete #1 only under **Ownership Interest Declaration**.

Please print or type responses clearly and legibly. Add additional pages if needed, being careful to identify each portion of the form to which each additional page refers.

This Statement is being made by the Applicant or Stock/Beneficial Interest Holder

This Statement is an: Original Statement or Amended Statement

Identifying Information:

Name: MacCullough Equipment INC.
 D/B/A: MacCullough Kubota FEIN # Only: 99-270-3126
 Street Address: 27130 S. LAGRANGE RD
 City: Frankfort State: IL Zip Code: 60423
 Phone No.: 708-305-6844 Fax Number: _____ Email: DWAWRZYNIEC@mcagplus.com

Cook County Business Registration Number: _____
 (Sole Proprietor, Joint Venture Partnership)

Corporate File Number (if applicable): 744-685-86

Form of Legal Entity:

- Sole Proprietor Partnership Corporation Trustee of Land Trust
- Business Trust Estate Association Joint Venture
- Other (describe) _____

Ownership Interest Declaration:

1. List the name(s), address, and percent ownership of each Person having a legal or beneficial interest (including ownership) of more than five percent (5%) in the Applicant/Holder.

Name	Address	Percentage Interest in Applicant/Holder
Matthew McCullough	21655 S. 108 th AVE Frankfort IL 60423	37.5%
Daniel Elliot	21675 S 108 th AVE Frankfort IL 60423	37.5%
Stephan McCullough	21420 Pioneer CT Frankfort IL 60423	20%

2. If the interest of any Person listed in (1) above is held as an agent or agents, or a nominee or nominees, list the name and address of the principal on whose behalf the interest is held.

Name of Agent/Nominee	Name of Principal	Principal's Address
NA		

3. Is the Applicant constructively controlled by another person or Legal Entity? [] Yes [] No
 If yes, state the name, address and percentage of beneficial interest of such person, and the relationship under which such control is being or may be exercised.

Name	Address	Percentage of Beneficial Interest	Relationship

Corporate Officers, Members and Partners Information:

For all corporations, list the names, addresses, and terms for all corporate officers. For all limited liability companies, list the names, addresses for all members. For all partnerships and joint ventures, list the names, addresses, for each partner or joint venture.

Name	Address	Title (specify title of Office, or whether manager or partner/joint venture)	Term of Office
Matthew McCullough	21655 S. 108 th AVE Frankfort 60423	President	
Stephan McCullough	21420 Pioneer CT Frankfort IL 60423	Vice President	
Debra McCullough	21416 Pioneer CT Frankfort, IL 60423	Sec	

Declaration (check the applicable box):

- I state under oath that the Applicant has withheld no disclosure as to ownership interest in the Applicant nor reserved any information, data or plan as to the intended use or purpose for which the Applicant seeks County Board or other County Agency action.
- I state under oath that the Holder has withheld no disclosure as to ownership interest nor reserved any information required to be disclosed.

COOK COUNTY DISCLOSURE OF OWNERSHIP INTEREST STATEMENT SIGNATURE PAGE

Matthew McCullough
Name of Authorized Applicant/Holder Representative (please print or type)

President
Title

Signature
Matthew @mckubota.com
E-mail address

11.4.25
Date
815-549-0955
Phone Number

Subscribed to and sworn before me
this 4 day of Nov, 2025

My commission expires: 3/2/2026

x Bobbi Clatterbuck
Notary Public Signature

Notary Seal

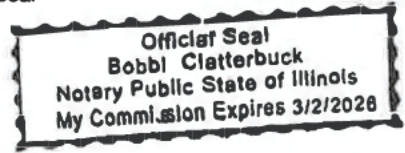



COOK COUNTY BOARD OF ETHICS
 69 W. WASHINGTON STREET, SUITE 3040
 CHICAGO, ILLINOIS 60602
 312/603-4304 Office 312/603-9988 Fax

FAMILIAL RELATIONSHIP DISCLOSURE PROVISION

Nepotism Disclosure Requirement:

Doing a significant amount of business with the County requires that you disclose to the Board of Ethics the existence of any familial relationships with any County employee or any person holding elective office in the State of Illinois, the County, or in any municipality within the County. The Ethics Ordinance defines a significant amount of business for the purpose of this disclosure requirement as more than \$25,000 in aggregate County leases, contracts, purchases or sales in any calendar year.

If you are unsure of whether the business you do with the County or a County agency will cross this threshold, err on the side of caution by completing the attached familial disclosure form because, among other potential penalties, any person found guilty of failing to make a required disclosure or knowingly filing a false, misleading, or incomplete disclosure will be prohibited from doing any business with the County for a period of three years. The required disclosure should be filed with the Board of Ethics by January 1 of each calendar year in which you are doing business with the County and again with each bid/proposal/quotation to do business with Cook County. The Board of Ethics may assess a late filing fee of \$100 per day after an initial 30-day grace period.

The person that is doing business with the County must disclose his or her familial relationships. If the person on the County lease or contract or purchasing from or selling to the County is a business entity, then the business entity must disclose the familial relationships of the individuals who are and, during the year prior to doing business with the County, were:

- its board of directors,
- its officers,
- its employees or independent contractors responsible for the general administration of the entity,
- its agents authorized to execute documents on behalf of the entity, and
- its employees who directly engage or engaged in doing work with the County on behalf of the entity.

Do not hesitate to contact the Board of Ethics at (312) 603-4304 for assistance in determining the scope of any required familial relationship disclosure.

Additional Definitions:

"*Familial relationship*" means a person who is a spouse, domestic partner or civil union partner of a County employee or State, County or municipal official, or any person who is related to such an employee or official, whether by blood, marriage or adoption, as a:

- | | | |
|----------------------------------|--|---------------------------------------|
| <input type="checkbox"/> Parent | <input type="checkbox"/> Grandparent | <input type="checkbox"/> Stepfather |
| <input type="checkbox"/> Child | <input type="checkbox"/> Grandchild | <input type="checkbox"/> Stepmother |
| <input type="checkbox"/> Brother | <input type="checkbox"/> Father-in-law | <input type="checkbox"/> Stepson |
| <input type="checkbox"/> Sister | <input type="checkbox"/> Mother-in-law | <input type="checkbox"/> Stepdaughter |
| <input type="checkbox"/> Aunt | <input type="checkbox"/> Son-in-law | <input type="checkbox"/> Stepbrother |
| <input type="checkbox"/> Uncle | <input type="checkbox"/> Daughter-in-law | <input type="checkbox"/> Stepsister |
| <input type="checkbox"/> Niece | <input type="checkbox"/> Brother-in-law | <input type="checkbox"/> Halfbrother |
| <input type="checkbox"/> Nephew | <input type="checkbox"/> Sister-in-law | <input type="checkbox"/> Halfsister |

COOK COUNTY BOARD OF ETHICS
FAMILIAL RELATIONSHIP DISCLOSURE FORM

A. PERSON DOING OR SEEKING TO DO BUSINESS WITH THE COUNTY

Name of Person Doing Business with the County: McCullough Equipment INC D/B/A McCullough Kubota

Address of Person Doing Business with the County: 27130 S. Lagrange RD Frankfort IL 60423

Phone number of Person Doing Business with the County: 815-658-2658

Email address of Person Doing Business with the County: DWAWRZYNIAC@mcaqplus.com

If Person Doing Business with the County is a Business Entity, provide the name, title and contact information for the individual completing this disclosure on behalf of the Person Doing Business with the County:

Matthew McCullough 815-549-0955 Pres.

B. DESCRIPTION OF BUSINESS WITH THE COUNTY

Append additional pages as needed and for each County lease, contract, purchase or sale sought and/or obtained during the calendar year of this disclosure (or the proceeding calendar year if disclosure is made on January 1), identify:

The lease number, contract number, purchase order number, request for proposal number and/or request for qualification number associated with the business you are doing or seeking to do with the County: 2457-10011R

The aggregate dollar value of the business you are doing or seeking to do with the County: \$ 1,206,696.00

The name, title and contact information for the County official(s) or employee(s) involved in negotiating the business you are doing or seeking to do with the County: Angelique Randle, Senior Contract Negotiator, Office of the Chief Procurement

Email: Angelique.randle@cookcountyl.gov Phone: 312-803-4478

The name, title and contact information for the County official(s) or employee(s) involved in managing the business you are doing or seeking to do with the County: Randy Piscilelli, Facilities and Equipment Manager, Department of Transportation and Highways,

Email: Peter.Gardenier@cookcountyl.gov, Ph: 773-843-6007

C. DISCLOSURE OF FAMILIAL RELATIONSHIPS WITH COUNTY EMPLOYEES OR STATE, COUNTY OR MUNICIPAL ELECTED OFFICIALS

Check the box that applies and provide related information where needed

The Person Doing Business with the County is an individual and there is no familial relationship between this individual and any Cook County employee or any person holding elective office in the State of Illinois, Cook County, or any municipality within Cook County.

The Person Doing Business with the County is a business entity and there is no familial relationship between any member of this business entity's board of directors, officers, persons responsible for general administration of the business entity, agents authorized to execute documents on behalf of the business entity or employees directly engaged in contractual work with the County on behalf of the business entity, and any Cook County employee or any person holding elective office in the State of Illinois, Cook County, or any municipality within Cook County.

**COOK COUNTY BOARD OF ETHICS
FAMILIAL RELATIONSHIP DISCLOSURE FORM**

- The Person Doing Business with the County is an individual and there is a familial relationship between this individual and at least one Cook County employee and/or a person or persons holding elective office in the State of Illinois, Cook County, and/or any municipality within Cook County. The familial relationships are as follows:

Name of Individual Doing Business with the County	Name of Related County Employee or State, County or Municipal Elected Official	Title and Position of Related County Employee or State, County or Municipal Elected Official	Nature of Familial Relationship
N/A			

If more space is needed, attach an additional sheet following the above format.

- The Person Doing Business with the County is a business entity and there is a familial relationship between at least one member of this business entity's board of directors, officers, persons responsible for general administration of the business entity, agents authorized to execute documents on behalf of the business entity and/or employees directly engaged in contractual work with the County on behalf of the business entity, on the one hand, and at least one Cook County employee and/or a person holding elective office in the State of Illinois, Cook County, and/or any municipality within Cook County, on the other. The familial relationships are as follows:

Name of Member of Board of Director for Business Entity Doing Business with the County	Name of Related County Employee or State, County or Municipal Elected Official	Title and Position of Related County Employee or State, County or Municipal Elected Official	Nature of Familial Relationship
N/A			

Name of Officer for Business Entity Doing Business with the County	Name of Related County Employee or State, County or Municipal Elected Official	Title and Position of Related County Employee or State, County or Municipal Elected Official	Nature of Familial Relationship
N/A			

Name of Person Responsible for the General Administration of the Business Entity Doing Business with the County	Name of Related County Employee or State, County or Municipal Elected Official	Title and Position of Related County Employee or State, County or Municipal Elected Official	Nature of Familial Relationship*
N/A			

Name of Agent Authorized to Execute Documents for Business Entity Doing Business with the County	Name of Related County Employee or State, County or Municipal Elected Official	Title and Position of Related County Employee or State, County or Municipal Elected Official	Nature of Familial Relationship*
N/A			

Name of Employee of Business Entity Directly Engaged in Doing Business with the County	Name of Related County Employee or State, County or Municipal Elected Official	Title and Position of Related County Employee or State, County or Municipal Elected Official	Nature of Familial Relationship*
N/A			

If more space is needed, attach an additional sheet following the above format.

VERIFICATION: To the best of my knowledge, the information I have provided on this disclosure form is accurate and complete. I acknowledge that an inaccurate or incomplete disclosure is punishable by law, including but not limited to fines and debarment.

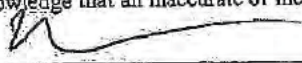
11-4-25

 Signature of Recipient Date

SUBMIT COMPLETED FORM TO: Cook County Board of Ethics
 69 West Washington Street, Suite 3040, Chicago, Illinois 60602
 Office (312) 603-4304 – Fax (312) 603-9988
 CookCounty.Ethics@cookcountyl.gov

* Spouse, domestic partner, civil union partner or parent, child, sibling, aunt, uncle, niece, nephew, grandparent or grandchild by blood, marriage (i.e. in laws and step relations) or adoption.

SECTION 4

COOK COUNTY AFFIDAVIT FOR WAGE THEFT ORDINANCE

Effective May 1, 2015, every Person, including Substantial Owners, seeking a Contract with Cook County must comply with the Cook County Wage Theft Ordinance set forth in Chapter 34, Article IV, Section 179. Any Person/Substantial Owner, who fails to comply with Cook County Wage Theft Ordinance, may request that the Chief Procurement Officer grant a reduction or waiver in accordance with Section 34-179(d).

"Contract" means any written document to make Procurements by or on behalf of Cook County.

"Person" means any individual, corporation, partnership, Joint Venture, trust, association, limited liability company, sole proprietorship or other legal entity.

"Procurement" means obtaining supplies, equipment, goods, or services of any kind.

"Substantial Owner" means any person or persons who own or hold a twenty-five percent (25%) or more percentage of interest in any business entity seeking a County Privilege, including those shareholders, general or limited partners, beneficiaries and principals; except where a business entity is an individual or sole proprietorship, Substantial Owner means that individual or sole proprietor.

All Persons/Substantial Owners are required to complete this affidavit and comply with the Cook County Wage Theft Ordinance before any Contract is awarded. Signature of this form constitutes a certification the information provided below is correct and complete, and that the individual(s) signing this form has/have personal knowledge of such information. County reserves the right to request additional information to verify veracity of information contained in this Affidavit.

I. Contract Information:

Contract Number: 2457-10011R

County Using Agency (requesting Procurement): DEPARTMENT OF TRANSPORTATION AND HIGHWAYS

II. Person/Substantial Owner Information:

Person (Corporate Entity Name): McCullough Equipment Inc. D/B/A McCullough Kubota

Substantial Owner Complete Name: Matthew McCullough

FEIN# 99-270-3126

Date of Birth: [REDACTED]

E-mail address: Matthew@McKubota.com

Street Address: 2055 S. 108th Ave

City: Frankfort

State: IL

Zip: 60423

Home Phone: [REDACTED]

III. Compliance with Wage Laws:

Within the past five years has the Person/Substantial Owner, in any judicial or administrative proceeding, been convicted of, entered a plea, made an admission of guilt or liability, or had an administrative finding made for committing a repeated or willful violation of any of the following laws:

- No Illinois Wage Payment and Collection Act, 820 ILCS 115/1 et seq., YES or NO
- No Illinois Minimum Wage Act, 820 ILCS 105/1 et seq., YES or NO
- No Illinois Worker Adjustment and Retraining Notification Act, 820 ILCS 65/1 et seq., YES or NO
- No Employee Classification Act, 820 ILCS 185/1 et seq., YES or NO
- No Fair Labor Standards Act of 1938, 29 U.S.C. 201, et seq., YES or NO
- No Any comparable state statute or regulation of any state, which governs the payment of wages YES or NO

If the Person/Substantial Owner answered "Yes" to any of the questions above, it is ineligible to enter into a Contract with Cook County, but can request a reduction or waiver under Section IV.

IV. Request for Waiver or Reduction

If Person/Substantial Owner answered "Yes" to any of the questions above, it may request a reduction or waiver in accordance with Section 34-179(d), provided that the request for reduction of waiver is made on the basis of one or more of the following actions that have taken place:

- No There has been a bona fide change in ownership or Control of the ineligible Person or Substantial Owner. YES or NO
- No Disciplinary action has been taken against the individual(s) responsible for the acts giving rise to the violation. YES or NO
- No Remedial action has been taken to prevent a recurrence of the acts giving rise to the disqualification or default. YES or NO
- No Other factors that the Person or Substantial Owner believe are relevant. YES or NO

The Person/Substantial Owner must submit documentation to support the basis of its request for a reduction or waiver. The Chief Procurement Officer reserves the right to make additional inquiries and request additional documentation.

V. Affirmation

The Person/Substantial Owner affirms that all statements contained in the Affidavit are true, accurate and complete.

Signature: _____ Date: 11.4.2015

Name of Person signing (Print): MATTEW MCCULLOUGH Title: Pres.

Subscribed and sworn to before me this 4 day of Nov, 20 25

x Bobbi Clatterbuck
Notary Public Signature

Notary Seal

Note: The above information is subject to verification prior to the award of the Contract.



SECTION 4

COOK COUNTY AFFIDAVIT FOR WAGE THEFT ORDINANCE

Effective May 1, 2015, every Person, **including Substantial Owners**, seeking a Contract with Cook County must comply with the Cook County Wage Theft Ordinance set forth in Chapter 34, Article IV, Section 179. Any Person/Substantial Owner, who fails to comply with Cook County Wage Theft Ordinance, may request that the Chief Procurement Officer grant a reduction or waiver in accordance with Section 34-179(d).

"Contract" means any written document to make Procurements by or on behalf of Cook County.

"Person" means any individual, corporation, partnership, Joint Venture, trust, association, limited liability company, sole proprietorship or other legal entity.

"Procurement" means obtaining supplies, equipment, goods, or services of any kind.

"Substantial Owner" means any person or persons who own or hold a twenty-five percent (25%) or more percentage of interest in any business entity seeking a County Privilege, including those shareholders, general or limited partners, beneficiaries and principals; except where a business entity is an individual or sole proprietorship, Substantial Owner means that individual or sole proprietor.

All Persons/Substantial Owners are required to complete this affidavit and comply with the Cook County Wage Theft Ordinance before any Contract is awarded. Signature of this form constitutes a certification the information provided below is correct and complete, and that the individual(s) signing this form has/have personal knowledge of such information. **County reserves the right to request additional information to verify veracity of information contained in this Affidavit.**

I. Contract Information:

Contract Number: 2457-10011R
County Using Agency (requesting Procurement): DEPARTMENT OF TRANSPORTATION AND HIGHWAYS

II. Person/Substantial Owner Information:

Person (Corporate Entity Name): McCullough Equipment Inc.D/B/A McCullough Kubota

Substantial Owner Complete Name: Daniel Elliot

FEIN# 99-270-3126

Date of Birth: [REDACTED] E-mail address: delliot@mckubota.com

Street Address: 21675 S 108th Ave.

City: Frankfort State: Illinois Zip: 60423

Home Phone: [REDACTED]

III. Compliance with Wage Laws:

Within the past five years has the Person/Substantial Owner, in any judicial or administrative proceeding, been convicted of, entered a plea, made an admission of guilt or liability, or had an administrative finding made for committing a repeated or willful violation of any of the following laws:

- No *Illinois Wage Payment and Collection Act, 820 ILCS 115/1 et seq., YES or NO*
- No *Illinois Minimum Wage Act, 820 ILCS 105/1 et seq., YES or NO*
- No *Illinois Worker Adjustment and Retraining Notification Act, 820 ILCS 65/1 et seq., YES or NO*
- No *Employee Classification Act, 820 ILCS 185/1 et seq., YES or NO*
- No *Fair Labor Standards Act of 1938, 29 U.S.C. 201, et seq., YES or NO*
- No *Any comparable state statute or regulation of any state, which governs the payment of wages YES or NO*

If the Person/Substantial Owner answered "Yes" to any of the questions above, it is ineligible to enter into a Contract with Cook County, but can request a reduction or waiver under **Section IV.**

IV. Request for Waiver or Reduction

If Person/Substantial Owner answered "Yes" to any of the questions above, it may request a reduction or waiver in accordance with Section 34-179(d), provided that the request for reduction of waiver is made on the basis of one or more of the following actions that have taken place:

- No There has been a bona fide change in ownership or Control of the ineligible Person or Substantial Owner. YES or NO
- No Disciplinary action has been taken against the individual(s) responsible for the acts giving rise to the violation. YES or NO
- No Remedial action has been taken to prevent a recurrence of the acts giving rise to the disqualification or default. YES or NO
- No Other factors that the Person or Substantial Owner believe are relevant. YES or NO

The Person/Substantial Owner must submit documentation to support the basis of its request for a reduction or waiver. The Chief Procurement Officer reserves the right to make additional inquiries and request additional documentation.

V. Affirmation

The Person/Substantial Owner affirms that all statements contained in the Affidavit are true, accurate and complete.

Signature: _____ Date: 12/3/2025

Name of Person signing (Print): Dan Elliot Title: COO/VP

Subscribed and sworn to before me this 3 day of December, 2025

x Bobbi Clatterbuck
Notary Public Signature

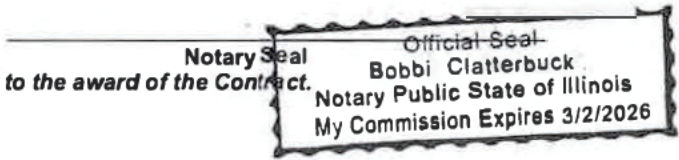

Note: The above information is subject to verification prior to the award of the Contract.

SECTION 5

CONTRACT AND EDS EXECUTION PAGE

The Applicant hereby certifies and warrants that all of the statements, certifications and representations set forth in this EDS are true, complete and correct; that the Applicant is in full compliance and will continue to be in compliance throughout the term of the Contract or County Privilege issued to the Applicant with all the policies and requirements set forth in this EDS; and that all facts and information provided by the Applicant in this EDS are true, complete and correct. The Applicant agrees to inform the Chief Procurement Officer in writing if any of such statements, certifications, representations, facts or information becomes or is found to be untrue, incomplete or incorrect during the term of the Contract or County Privilege.

McCullough Equipment Inc
DBA McCullough Kubota
Corporation's Name
815.549.0955
Telephone
Secretary Signature

Execution by Corporation Matthew McCullough
President's Printed Name and Signature
matthew@McKubota.com
Email
12/17/25
Date

Execution by LLC

LLC Name
Date

*Member/Manager Printed Name and Signature
Telephone and Email

Execution by Partnership/Joint Venture

Partnership/Joint Venture Name
Date

*Partner/Joint Venturer Printed Name and Signature
Telephone and Email

Execution by Sole Proprietorship

Printed Name Signature
Date

Assumed Name (if applicable)
Telephone and Email

Subscribed and sworn to before me this
day of , 20

Notary Public Signature

My commission expires:
Notary Seal



*If the operating agreement, partnership agreement or governing documents requiring execution by multiple members, managers, partners, or joint venturers, please complete and execute additional Contract and EDS Execution Pages.

